



Micro Tube-HF 60 * (10x6)-0.4 TY Y 27.3-00214534-116:2019

Fiber optic distribution cables of micro-tube construction with flame-retardant, halogen-free and low smoking (HFFR) polymer compound sheath

Mark formation:

Micro Tube-HF 60[c](10x6)-0.4

[c] type of optical fiber

- *A – single-mode with extended wavelength band (ITU-T G.652D, ITU-T G.657A1)*
- *D – single-mode, not sensitive to losses on macro-bending (ITU-T G.657A2)*

Order placing: sample of indication

Micro Tube-HF 60A(10x6)-0.4

Cable construction provides fast access to micro-tubes and fibres (no tools required), minimum of sealing compound and avoiding the risk of micro-tube kinking

Cables are used for:

- *for digital signal transmission in optic local networks as distribution cables*
- *for compact outdoor installation in PE ducts by pulling or floating techniques*
- *in areas with exclusive fire safety requirements*

Fire safety code in accordance with ДСТУ 4809:2007: ПБ103122000

Products of this mark meet the requirements:

- *single wire cable flame retardance*
- *toxicity class Tk3 of the combustion products of nonmetallic elements (toxicity index over 120 g/m³)*
- *class ДТк1 on smoke-forming ability by smouldering of non-metallic elements (coefficient of smoke formation from 50 to 500 m²/kg)*
- *class ДПк2 on smoke-forming ability by combustion (minimum luminous flux more than 60 %)*
- *corrosive class Kк2 of combustion products of non-metallic elements (the number of halogen hydrides less than 150 mg/g, pH more than 4.3, specific conductivity less than 10 μS/mm)*



Micro Tube-HF 60 * (10x6)-0.4 TY Y 27.3-00214534-116:2019

Fiber optic distribution cables of micro-tube construction with flame-retardant, halogen-free and low smoking (HFFR) polymer compound sheath

TECHNICAL SPECIFICATIONS

Number of optical micro-tube in cable		10
Number of optical fibers in cable	units	60
Permissible tensile force (short-term)	N	400
Permissible tensile force (continuous)	N	200
Permissible crushing force, no less than	N/10 sm	1500
Ambient temperature		
• during operation	°C	-30 ... +70
• during storage and transportation	°C	-30 ... +70
• during laying and installation	°C	-10 ... +40
Cable weight (approximate)	kg/km	40
Rated outer diameter of the cable (for reference) **	mm	7
Minimum bending radius during laying	mm	140
Minimum bending radius during operation	mm	70

Notes:

When ordering it is necessary to agree the factory length of the product with the manufacturer

** The external diameter may differ from the rated up to $\pm 10\%$

CONSTRUCTION

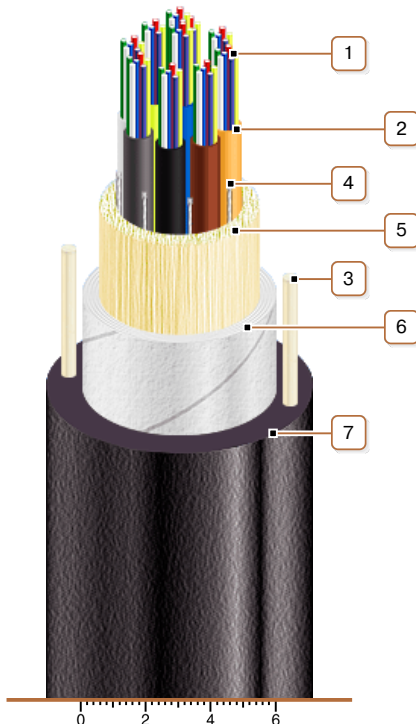

1. Optic fibers
2. Tube of fiber optic micromodule
3. Fiberglass rod in sheath
4. Water-blocking thread
5. Aramid-thread or glass-thread layer
6. Lapping layer of water-blocking tape
7. Outer sheath of halogen-free flame retardant polymer composition with low smoke emission

Note: Optical module twisting is not illustrated.