



Micro Tube 360 * (30x12)-1.7 TY Y 27.3-00214534-116:2019

Fiber optic distribution cables of micro-tube construction with HDPE sheath

Mark formation:

Micro Tube 360[c](30x12)-1.7

[c] type of optical fiber

- A – single-mode with extended wavelength band (ITU-T G.652D, ITU-T G.657A1)
- D - single-mode, not sensitive to losses on macro-bending (ITU-T G.657A2)

Order placing: sample of indication

Micro Tube 360A(30x12)-1.7

Cable construction provides fast access to micro-tubes and fibres (no tools required), minimum of sealing compound and avoiding the risk of micro-tube kinking

Cables are used for:

- for digital signal transmission in optic local networks as distribution cables
- for compact outdoor installation in PE ducts by pulling or floating techniques

TECHNICAL SPECIFICATIONS

Number of optical micro-tube in cable		30
Number of optical fibers in cable	units	360
Permissible tensile force (short-term)	N	1700
Permissible tensile force (continuous)	N	850
Permissible crushing force, no less than	N/10 sm	1500
Ambient temperature		
• during operation	°C	-30 ... +70
• during storage and transportation	°C	-30 ... +70
• during laying and installation	°C	-10 ... +40
Cable weight (approximate)	kg/km	160
Rated outer diameter of the cable (for reference) **	mm	14.2
Minimum bending radius during laying	mm	284
Minimum bending radius during operation	mm	142

Notes:

When ordering it is necessary to agree the factory length of the product with the manufacturer

** The external diameter may differ from the rated up to $\pm 10\%$



Micro Tube 360 * (30x12)-1.7 TY Y 27.3-00214534-116:2019

Fiber optic distribution cables of micro-tube construction with HDPE sheath

CONSTRUCTION

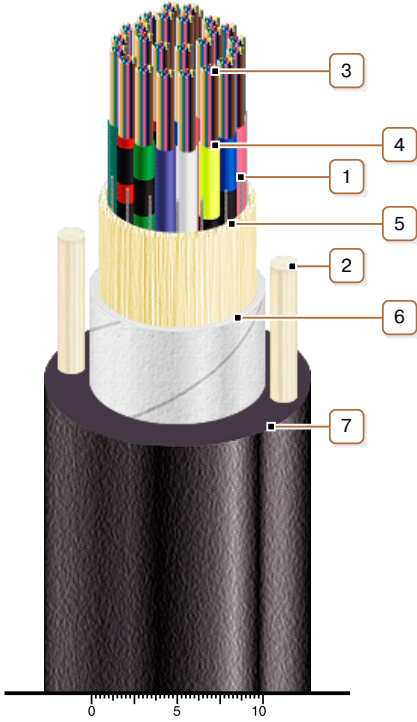

1. Water-blocking thread
2. Fiberglass rod in sheath
3. Optic fibers
4. Tube of fiber optic micromodule
5. Aramid-thread or glass-thread layer
6. Lapping layer of water-blocking tape
7. HDPE outer sheath

Note: Optical module twisting is not illustrated.