



КПоЭПЭнг-FRHF 14x2.5 ТУ У 27.3-00214534-084:2016

Fire resistant control cables with copper conductors, with insulation made of halogen-free cross-linked polymer composition, sheathed with halogen-free polymer composition, with screened cores and collective screen

For the cable of this mark correspond the foreign-made analogues:

КПоЭПЭнг-FRHF (RU)

Used:

- for transmission of electrical signals, and distribution of electric energy in stationary electrical equipment for alternating voltages up to 660 V frequency up to 100 Hz, and DC voltage up to 1000 V, inside and outside the hermetic zone of nuclear power stations (NPS)
- for multi-cable installation (acc. GOST 31565:2012) in cable channels and premises of internal electrical installations
- for use in systems having security class 2 (A), 3 (B), 3 (C), and 4 according to the classification of НП 306.2.141-2008 and НП 306.2.202-2015

Fire safety code in accordance with ДСТУ 4809:2007: ПБ123122050

Products of this mark meet the requirements:

- single wire cable flame retardance
- bunched cable flame retardance category A
- toxicity class Tk3 of the combustion products of non-metallic elements (toxicity index over 120 g/m³)
- class ДТк1 on smoke-forming ability by smouldering of non-metallic elements (coefficient of smoke formation from 50 to 500 m²/kg)
- class ДПк2 on smoke-forming ability by combustion (minimum luminous flux more than 60 %)
- corrosive class Кк2 of combustion products of non-metallic elements (the number of halogen hydrides less than 150 mg/g, pH more than 4.3, specific conductivity less than 10 μS/mm)
- flame-resistant class FE90 under fire conditions with a temperature not less than 750 °C



КПоЭПЭнг-FRHF 14x2.5 ТУ У 27.3-00214534-084:2016

Fire resistant control cables with copper conductors, with insulation made of halogen-free cross-linked polymer composition, sheathed with halogen-free polymer composition, with screened cores and collective screen

TECHNICAL SPECIFICATIONS

Rated AC voltage of no more than 100 Hz	V	660
Rated DC voltage	V	1000
Number and rated diameter of conductors	mm ²	14 x 2.5
Operating temperature range	°C	-50 ... +60
Permissible continuous conductors temperature	°C	+90
Minimum bending radius by laying	mm	193
Cable outer diameter (for reference only) **	mm	32.1
Cable weight (approximate)	kg/km	1561

Notes:

When ordering it is necessary to agree the factory length of the product with the manufacturer

** The external diameter may differ from the rated up to ± 10 %

CONSTRUCTION

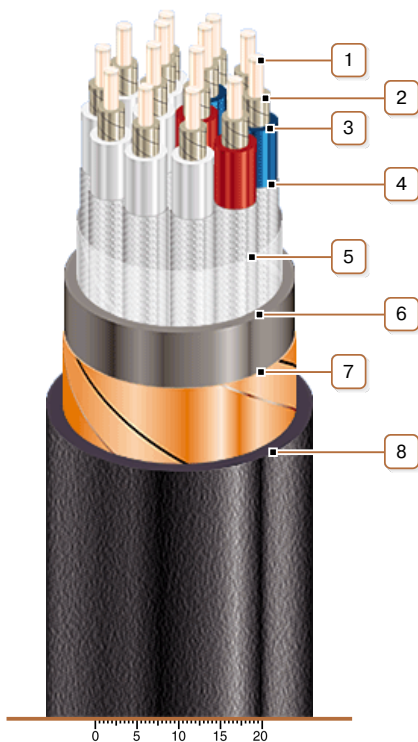

1. Copper conductor
2. Fire-resistant barrier
3. Insulation of cross-linked halogen-free polymer composition or cross-linked polyethylene
4. Insulation screen - tinned copper or copper wires braid
5. Wrapping the core with polyethylene terephthalate film
6. Halogen-free polymer compound inner sheath
7. Collective screen of copper tapes
8. Outer sheath of flame-retardant halogen-free polymer composition