



КПЭТИнг-FRHF 12x2x0.7-ХК ТУ У 27.3-00214534-084:2016

Measuring paired cables, fire, heat and radiation resistant, with copper and/or chromel-copel and chromel-alumel conductors, with insulation and sheath made of cross-linked halogen-free polymer composition, with collective screen

For the cable of this mark correspond the foreign-made analogues:

КПЭТИнг-FRHF (RU)

Used:

- for low-level signals transmission, including information gathering systems and communication lines of Assembly of core detectors (СВД) and thermal control inside and outside the under containment zone of nuclear power stations (NPS)
- for multi-cable installation (acc. GOST 31565:2012) in cable channels and premises of internal electrical installations
- for use in systems having security class 2 (A), 3 (B), 3 (C), and 4 according to the classification of НП 306.2.141-2008 and НП 306.2.202-2015

Cables without inner sheath can also be manufactured

Fire safety code in accordance with ДСТУ 4809:2007: ПБ133122020

Products of this mark meet the requirements:

- single wire cable flame retardance
- bunched cable flame retardance category B
- toxicity class Tk3 of the combustion products of nonmetallic elements (toxicity index over 120 g/m³)
- class ДТк1 on smoke-forming ability by smouldering of non-metallic elements (coefficient of smoke formation from 50 to 500 m²/kg)
- class ДПк2 on smoke-forming ability by combustion (minimum luminous flux more than 60 %)
- corrosive class Kk2 of combustion products of non-metallic elements (the number of halogen hydrides less than 150 mg/g, pH more than 4.3, specific conductivity less than 10 μS/mm)
- flame-resistant class FE30 under fire conditions with a temperature not less than 750 °C



КПЭТИнг-FRHF 12x2x0.7-ХК ТУ У 27.3-00214534-084:2016

Measuring paired cables, fire, heat and radiation resistant, with copper and/or chromel-copel and chromel-alumel conductors, with insulation and sheath made of cross-linked halogen-free polymer composition, with collective screen

TECHNICAL SPECIFICATIONS

Number of pairs and nominal conductor diameter	mm	12 x 0.7
Operating temperature range	°C	-50 ... +60
Permissible continuous conductors temperature	°C	+90
Minimum bending radius by laying	mm	197
Cable outer diameter (for reference only) **	mm	32.7
Cable weight (approximate)	kg/km	1106

Notes:

Cables with stranded copper conductors of flexibility class 4 with nominal cross-section 0.35 and 0.50 mm can also be manufactured
When ordering it is necessary to agree the factory length of the product with the manufacturer

** The external diameter may differ from the rated up to $\pm 10\%$

CONSTRUCTION

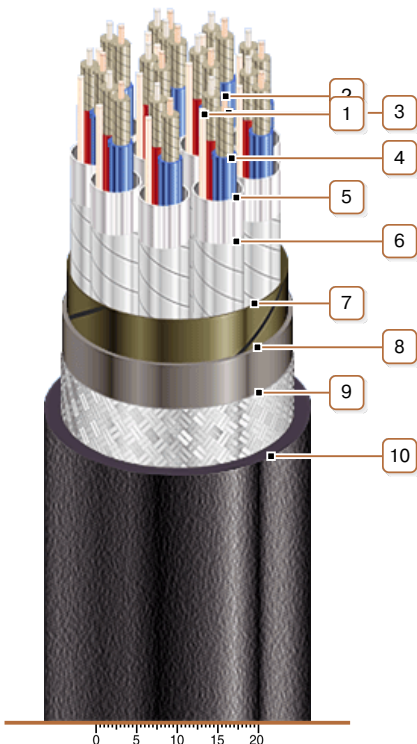

1. Contact conductor of copper or tinned copper wire
2. Current-carrying conductor (Chromel- Cu-Mn-Ni alloy)
3. Fire-resistant barrier
4. Insulation of cross-linked halogen-free polymer composition or cross-linked polyethylene
5. Wrapping with metallized PET film
6. Wrapping with polymer tape
7. Wrapping the core with glass tape or mica glass tape
8. Halogen-free polymer compound inner sheath
Note: Cables without inner sheath can also be manufactured
9. Collective screen - tinned copper or copper wires braid
10. Outer sheath of flame-retardant halogen-free cross-linked polymer composition