



ПВСнгд 4 x 1 **ТУ У 31.3-00214534-059:2008**

Connecting wires with copper conductors, low fire-risk PVC compound insulation, low fire-risk PVC compound outer sheath

Used for:

- *laying in dry and damp areas, for installation in switchboards, in ducts, for concealed and open wiring on the walls, in the networks for AC voltage up to 380 V (for systems up to 380/660 V)*
- *connection of household and repair electric appliances and tools, dishwashers, refrigerators etc., labor-saving devices for gardening, and other machines and devices of this kind*

Fire safety code in accordance with ДСТУ 4809:2007: ПБ123121000

Products of this mark meet the requirements:

- *single wire cable flame retardance*
- *bunched cable flame retardance category A*
- *toxicity class Tk3 of the combustion products of nonmetallic elements (toxicity index over 120 g/m³)*
- *class ДТк1 on smoke-forming ability by smouldering of non-metallic elements (coefficient of smoke formation from 50 to 500 m²/kg)*
- *class ДПк2 on smoke-forming ability by combustion (minimum luminous flux more than 60 %)*
- *corrosive class Кк1 of combustion products of non-metallic elements (the number of halogen hydrides less than 150 mg/g, pH less than 4.3, specific conductivity more than 10 μS/mm)*

TECHNICAL SPECIFICATIONS

Rated voltage	kV	0.38
Number and rated area of conductors	mm ²	4 x 1
Insulation thickness	mm	0.6
Permissible continuous current by aerial laying	A	10
Operating temperature range	°C	-15 ... +50
Flexibility class acc. to ГОСТ 22483-77		5
Minimum bending radius by laying	mm	38.5
Outer diameter (nominal, for reference only)	mm	7.7
Weight (approximate)	kg/km	100

Notes:

When ordering it is necessary to agree the factory length of the product with the manufacturer



ПВСнгд 4 x 1 ТУ У 31.3-00214534-059:2008

Connecting wires with copper conductors, low fire-risk PVC compound insulation, low fire-risk PVC compound outer sheath

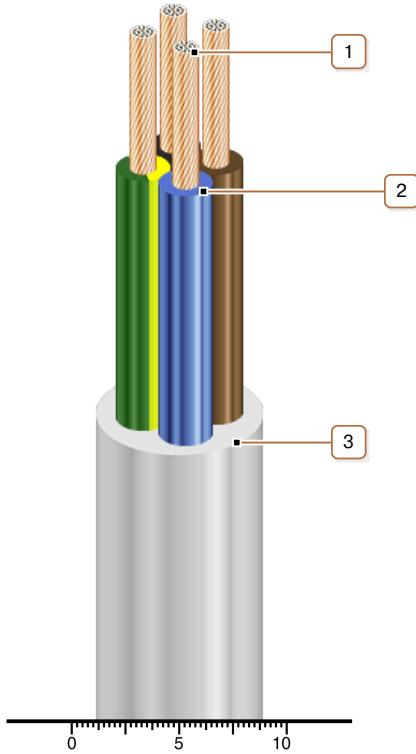

CONSTRUCTION

1. Copper multiwire conductor
2. Low fire-risk PVC compound insulation
3. Low fire-risk PVC compound outer sheath

Note: Conductor twisting is not illustrated