



## БК6ШВ 3x2.5-0.66 TY Y 31.3-00214534-057:2007

Power cables with copper conductors, with PVC-compound insulation, galvanized steel-wire armoured, with PVC-compound protection hose

Cables are used for laying:

- *single laying*
- *in premises, dry ducts and tunnels, in corrosive environment*
- *in places, where small mechanical impacts on cable are possible, including tensile forces*

It is possible manufacturing of cables in cold-resistant performance (БК6ШВ-ХЛ)

Fire safety code in accordance with ДСТУ 4809:2007: ПБ100000000

Products of this mark meet the requirements:

- *single wire cable flame retardance*

### TECHNICAL SPECIFICATIONS

Rated voltage	kV	0.66
Number and rated area of conductors	mm <sup>2</sup>	3 x 2.5
Insulation thickness	mm	0.6
Armor wire diameter	mm	0.3
Permissible continuous current rating *		
• <i>by aerial laying (AC of industrial frequency) *</i>	A	27
• <i>by burial (AC of industrial frequency) *</i>	A	36
Maximum permissible conductor temperature		
• <i>Continuous</i>	°C	+70
• <i>in emergency operation</i>	°C	+80
• <i>at short circuit</i>	°C	+160
Operating temperature range	°C	-50 ... +50
Minimum bending radius by laying	mm	90
Rated outer diameter of the cable (for reference) **	mm	12
Cable weight (approximate)	kg/km	240
Rated factory cable length and gross weight of the delivery on the drums	m, t	# 10: 1650 • 0.5

Notes:

When ordering it is necessary to agree the factory length of the product with the manufacturer

\* Long permissible current loads are calculated for the following conditions: air temperature plus 25 °C, soil temperature plus 15 °C, thermal resistivity of soil 1.2 °K·m/W, laying depth in the soil 0.7 m

\*\* The external diameter may differ from the rated up to ± 10 %



**БКШВ 3x2.5-0.66**  
**ТУ У 31.3-00214534-057:2007**

Power cables with copper conductors, with PVC-compound insulation, galvanized steel-wire armoured, with PVC-compound protection hose

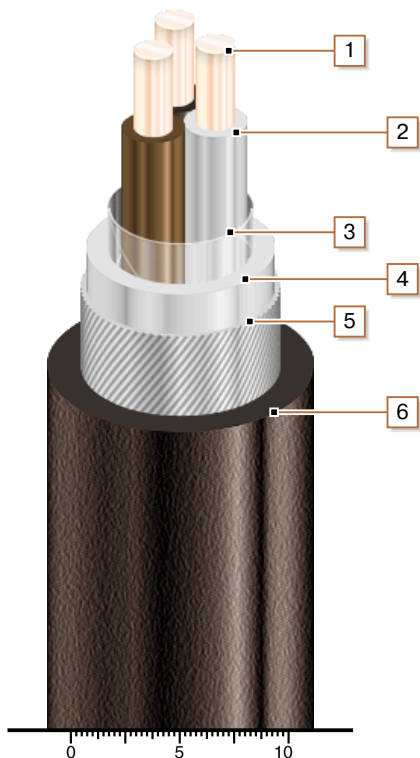

### CONSTRUCTION

1. Copper conductor
2. PVC compound insulation
3. PET film winding
4. PVC compound belt insulation
5. Round galvanized steel-wire armour
6. Pressed PVC compound protection hose

Note: conductor twisting is not illustrated