

КПБ6Пнг-НФ 5x2.5 ТУ У 31.3-00214534-069:2011

Control halogen-free cables with copper conductors, galvanized double steel-tape armoured, with halogen-free polymer compound insulation, polymer compound sheath

Cables are used for laying:

- in premises, dry ducts and tunnels, in corrosive environment
- in places, where small mechanical impacts on cable are possible, including tensile forces
- in bunches
- power supply cable lines of NPP electric equipment, wiring in office premises, which are computerized and intelligent, in kindergartens, schools, hospitals and for cable lines of spectating complexes and sport structures

Fire safety code in accordance with ДСТУ 4809:2007: ПБ123122000

Products of this mark meet the requirements:

- single wire cable flame retardance
- bunched cable flame retardance category A
- toxicity class Tk3 of the combustion products of nonmetallic elements (toxicity index over 120 g/m³)
- class ДТк1 on smoke-forming ability by smouldering of non-metallic elements (coefficient of smoke formation from 50 to 500 m²/kg)
- class ДПк2 on smoke-forming ability by combustion (minimum luminous flux more than 60 %)
- corrosive class Kk2 of combustion products of non-metallic elements (the number of halogen hydrides less than 150 mg/g, pH more than 4.3, specific conductivity less than 10 μS/mm)

TECHNICAL SPECIFICATIONS

Rated voltage (AC / DC)	V	660 / 1000
Number and rated area of conductors	mm ²	5 x 2.5
Minimum bending radius by laying	mm	160
Cable outer diameter (for reference only) **	mm	16
Cable weight (approximate)	kg/km	490
Rated factory cable length and gross weight of the delivery on the drums ***	m, t	# 12: 1280 · 0.7

Notes:

When ordering it is necessary to agree the factory length of the product with the manufacturer

** The external diameter may differ from the rated up to ± 10 %



КПБ6Пнг-НГ 5x2.5 ТУ У 31.3-00214534-069:2011

Control halogen-free cables with copper conductors, galvanized double steel-tape armoured, with halogen-free polymer compound insulation, polymer compound sheath

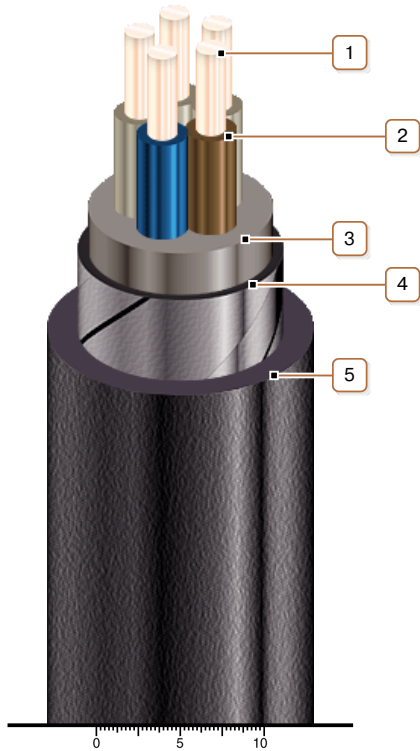

CONSTRUCTION

1. Copper conductor
2. Halogen-free polymer compound insulation
3. Halogen-free polymer compound inner sheath
4. Double galvanized steel-tape armour
5. Polymer compound outer sheath: flame-retardant and halogen-free

Note: Conductor twisting is not illustrated