



КВВГнгд 4х6 ТУ У 31.3-00214534-018-2003

Control flame-retardant cables with copper conductors, low fire-risk PVC compound insulation, PVC compound sheath, low smoke and gas emission

Cables are used for laying:

- *in premises, dry ducts and tunnels, in corrosive environment*
- *with no risk of mechanical damage in operation*
- *in bunches, in crowded places*

Fire safety code in accordance with ДСТУ 4809:2007: ПБ123121000

Products of this mark meet the requirements:

- *single wire cable flame retardance*
- *bunched cable flame retardance category A*
- *toxicity class Tk3 of the combustion products of nonmetallic elements (toxicity index over 120 g/m³)*
- *class ДТк1 on smoke-forming ability by smouldering of non-metallic elements (coefficient of smoke formation from 50 to 500 m²/kg)*
- *class ДПк2 on smoke-forming ability by combustion (minimum luminous flux more than 60 %)*
- *corrosive class Кк1 of combustion products of non-metallic elements (the number of halogen hydrides less than 150 mg/g, pH less than 4.3, specific conductivity more than 10 μS/mm)*

TECHNICAL SPECIFICATIONS

Rated voltage (AC / DC)	V	660 / 1000
Number and rated area of conductors	mm ²	4 x 6
Minimum bending radius by laying	mm	78
Cable outer diameter (for reference only) **	mm	13
Cable weight (approximate)	kg/km	340
Rated factory cable length and gross weight of the delivery on the drums	m, t	# 10: 1410 • 0.6

Notes:

When ordering it is necessary to agree the factory length of the product with the manufacturer

*** The external diameter may differ from the rated up to ± 10 %*

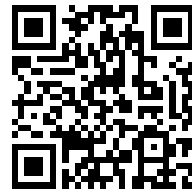

КВВГнгд 4х6 ТУ У 31.3-00214534-018-2003

Control flame-retardant cables with copper conductors, low fire-risk PVC compound insulation, PVC compound sheath, low smoke and gas emission

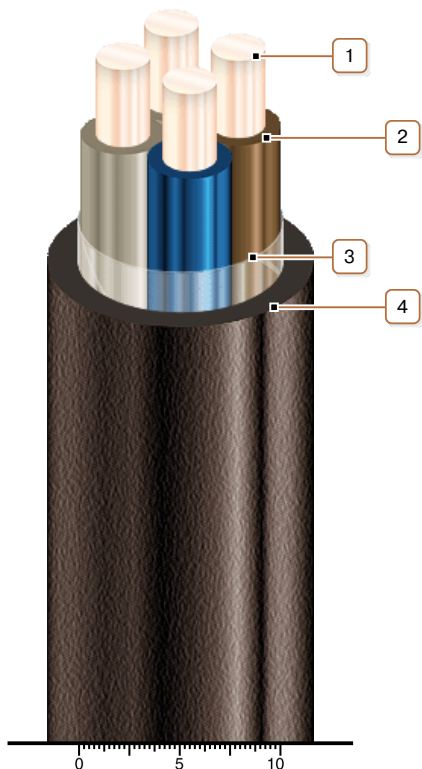

CONSTRUCTION

1. Copper conductor
2. Low fire-risk PVC compound insulation
3. PET film winding
4. Low fire-risk PVC compound outer sheath

Note: Conductor twisting is not illustrated