



ВВГнг-К 3x50/35-1 ТУ У 31.3-00214534-048:2007

Power cables with copper conductors, with PVC compound insulation, with concentric conductor, with low-flammable PVC-compound protection hose

Cables are used for laying:

- *in bunches*
- *in premises, dry ducts and tunnels, in corrosive environment*
- *in locations, where a high level of electrical protection is required*

It is possible to manufacture armoured cable

Fire safety code in accordance with ДСТУ 4809:2007: ПБ120000000

Products of this mark meet the requirements:

- *single wire cable flame retardance*
- *bunched cable flame retardance category A*

TECHNICAL SPECIFICATIONS

Rated voltage	kV	1
Number and rated area of conductors	mm ²	3 x 50
Nominal cross-section area of concentric conductor	mm ²	35
Phase insulation thickness	mm	1.4
Permissible continuous current rating (AC of industrial frequency) *		
• <i>by aerial laying</i>	A	167
• <i>by burial</i>	A	187
Maximum permissible conductor temperature		
• <i>Continuous</i>	°C	+70
• <i>at short circuit</i>	°C	+160
Operating temperature range	°C	-50 ... +50
Minimum bending radius by laying	mm	262.5
Rated outer diameter of the cable (for reference) **	mm	35
Cable weight (approximate)	kg/km	2580
Rated factory cable length and gross weight of the delivery on the drums	m, t	# 16a: 780 • 2.3 # 18: 890 • 2.8

Notes:

When ordering it is necessary to agree the factory length of the product with the manufacturer

** Long permissible current loads are calculated for the following conditions: air temperature plus 25 °C, soil temperature plus 15 °C, thermal resistivity of soil 1.2 °K·m/W, laying depth in the soil 0.7 m*

*** The external diameter may differ from the rated up to ± 10 %*



ВВГнг-К 3x50/35-1 **ТУ У 31.3-00214534-048:2007**

Power cables with copper conductors, with PVC compound insulation, with concentric conductor, with low-flammable PVC-compound protection hose

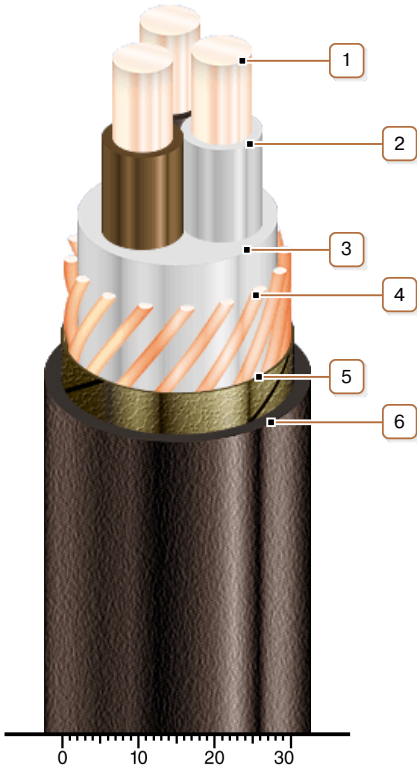

CONSTRUCTION

1. *Copper conductor*
2. *PVC compound insulation*
3. *PVC compound belt insulation*
4. *Concentric copper conductor*
5. *Lapping layer of nonwoven cloth tape*
6. *Low flammable PVC compound outer sheath*

Note: Conductor twisting is not illustrated