



ПВКВнг 4x25-1 ТУ У 31.3-00214534-016-2003

Power cables with copper conductors, XLPE-insulated, galvanized steel-wire armoured, with low-flammable PVC-compound outer sheath

Cables are used for laying:

- *in bunches*
- *in premises, dry ducts and tunnels, in corrosive environment*
- *in places, where intense tensile forces are possible (in cable lifting, in bulk, heaving, boggy, everfrost soils)*

Manufacturing of cables with a different number and different design of conductors is possible
 Manufacturing of single-phase cables with aluminium-wire armour is possible

Fire safety code in accordance with ДСТУ 4809:2007: ПБ130000000

Products of this mark meet the requirements:

- *single wire cable flame retardance*
- *bunched cable flame retardance category B*

TECHNICAL SPECIFICATIONS

Rated voltage	kV	1
Number and rated area of conductors	mm ²	4 x 25
Phase insulation thickness	mm	0.9
Armor wire diameter	mm	1.4
Permissible continuous current rating (AC of industrial frequency) *		
• <i>by aerial laying</i>	A	131
• <i>by burial</i>	A	133
Maximum permissible conductor temperature		
• <i>Continuous</i>	°C	+90
• <i>at short circuit</i>	°C	+250
Operating temperature range	°C	-50 ... +50
Minimum bending radius by laying	mm	168
Rated outer diameter of the cable (for reference) **	mm	28
Cable weight (approximate)	kg/km	1950
Rated factory cable length and gross weight of the delivery on the drums	m, t	# 14: 800 • 1.7

Notes:

When ordering it is necessary to agree the factory length of the product with the manufacturer

** Long permissible current loads are calculated during operation in four-wire networks with load in all the conductors for the following conditions: air temperature plus 25 °C, soil temperature plus 15 °C, thermal resistivity of soil 1.2 °K·m/W, laying depth in the soil 0.7 m*

*** The external diameter may differ from the rated up to ± 10 %*

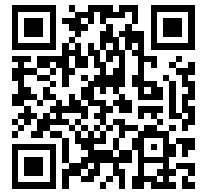

ПвКВнг 4x25-1 ТУ У 31.3-00214534-016-2003

Power cables with copper conductors, XLPE-insulated, galvanized steel-wire armoured, with low-flammable PVC-compound outer sheath

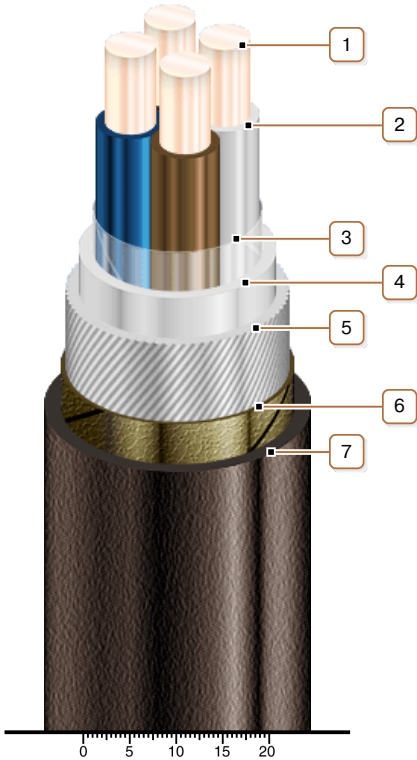

CONSTRUCTION

1. Copper conductor
2. XLPE insulation
3. PET film winding
4. PVC compound belt insulation
5. Round galvanized steel-wire armour
Note: Manufacturing of single-phase cables with aluminium-wire armour is possible
6. Lapping layer of nonwoven cloth tape
7. Low flammable PVC compound outer sheath

Note: Conductor twisting is not illustrated