



АВЗКВнг 4x10 (ож)-1 TY Y 31.3-00214534-016-2003

Power cables with aluminium conductors, with PVC compound insulation, with filling of intermediate spaces between the conductors, round-steel-wire armoured, with low-flammable PVC compound outer sheath

Cables are used for laying:

- *in bunches*
- *in premises, dry ducts and tunnels, in corrosive environment*
- *in places, where intense tensile forces are possible (in cable lifting, in bulk, heaving, boggy, everfrost soils)*

Manufacturing of cables with a different number and different design of conductors is possible

Manufacturing of single-phase cables with aluminium-wire armour is possible

Fire safety code in accordance with ДСТУ 4809:2007: ПБ130000000

Products of this mark meet the requirements:

- *single wire cable flame retardance*
- *bunched cable flame retardance category B*

TECHNICAL SPECIFICATIONS

Rated voltage	kV	1
Number and rated area of conductors	mm ²	4 x 10
Phase insulation thickness	mm	1
Armor wire diameter	mm	1.4
Permissible continuous current rating (AC of industrial frequency) *		
• <i>by aerial laying</i>	A	46
• <i>by burial</i>	A	54
Maximum permissible conductor temperature		
• <i>Continuous</i>	°C	+70
• <i>at short circuit</i>	°C	+160
Operating temperature range	°C	-50 ... +50
Minimum bending radius by laying	mm	184
Rated outer diameter of the cable (for reference) **	mm	23
Cable weight (approximate)	kg/km	1090
Rated factory cable length and gross weight of the delivery on the drums	m, t	# 14: 1090 • 1.4

Notes:

When ordering it is necessary to agree the factory length of the product with the manufacturer

** Long permissible current loads are calculated during operation in four-wire networks with load in all the conductors for the following conditions: air temperature plus 25 °C, soil temperature plus 15 °C, thermal resistivity of soil 1.2 °K·m/W, laying depth in the soil 0.7 m*

*** The external diameter may differ from the rated up to ± 10 %*



АВЗКВнг 4x10 (ож)-1 ТУ У 31.3-00214534-016-2003

Power cables with aluminium conductors, with PVC compound insulation, with filling of intermediate spaces between the conductors, round-steel-wire armoured, with low-flammable PVC compound outer sheath

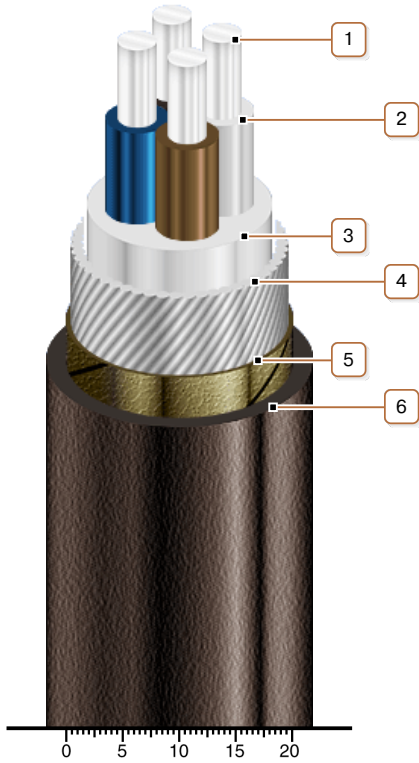

CONSTRUCTION

1. Aluminium conductor
2. PVC compound insulation
3. PVC compound belt insulation
4. Round galvanized steel-wire armour
Note: Manufacturing of single-phase cables with aluminium-wire armour is possible
5. Lapping layer of nonwoven cloth tape
6. Low flammable PVC compound outer sheath

Note: Conductor twisting is not illustrated