



АПВЗКП 4x150-1 ТУ У 31.3-00214534-016-2003

Power cables with aluminium conductors, XLPE-insulated, with filling of intermediate spaces between the conductors, round-steel-wire armoured, with polyethylene outer sheath

Cables are used for laying:

- in premises, tunnels, collectors, in soil (trenches), in corrosive environment
- in places, where intense tensile forces are possible (in cable lifting, in bulk, heaving, boggy, everfrost soils)
- in water at depth up to 10 m

Manufacturing of cables with a different number and different design of conductors is possible

Manufacturing of single-phase cables with aluminium-wire armour is possible

Fire safety code in accordance with ДСТУ 4809:2007: ПБ100000000

Products of this mark meet the requirements:

- single wire cable flame retardance

TECHNICAL SPECIFICATIONS

Rated voltage	kV	1
Number and rated area of conductors	mm ²	4 x 150
Phase insulation thickness	mm	1.4
Armor wire diameter	mm	2.8
Permissible continuous current rating (AC of industrial frequency) *		
• by aerial laying	A	306
• by burial	A	278
Maximum permissible conductor temperature		
• Continuous	°C	+90
• at short circuit	°C	+250
Operating temperature range	°C	-60 ... +50
Minimum bending radius by laying	mm	432
Rated outer diameter of the cable (for reference) **	mm	54
Cable weight (approximate)	kg/km	9150
Rated factory cable length and gross weight of the delivery on the drums	m, t	# 18: 400 • 4.1 # 20: 630 • 6.4

Notes:

When ordering it is necessary to agree the factory length of the product with the manufacturer

* Long permissible current loads are calculated during operation in four-wire networks with load in all the conductors for the following conditions: air temperature plus 25 °C, soil temperature plus 15 °C, thermal resistivity of soil 1.2 °K·m/W, laying depth in the soil 0.7 m

** The external diameter may differ from the rated up to ± 10 %



АПВЗКП 4x150-1 ТУ У 31.3-00214534-016-2003

Power cables with aluminium conductors, XLPE-insulated, with filling of intermediate spaces between the conductors, round-steel-wire armoured, with polyethylene outer sheath

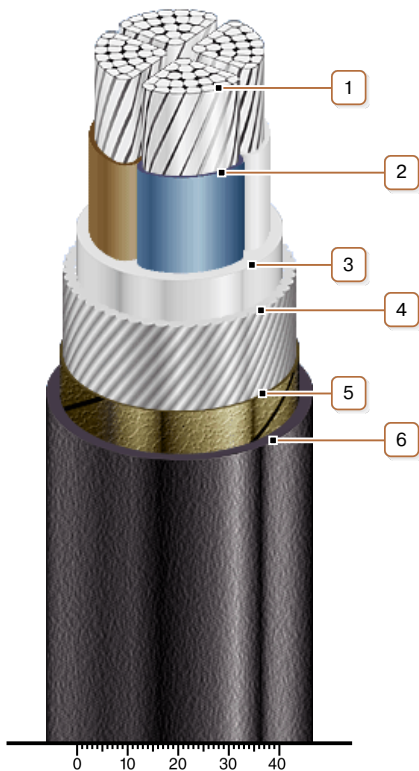

CONSTRUCTION

1. Aluminium multiwire compacted conductor

2. XLPE insulation

3. PVC compound belt insulation

4. Round galvanized steel-wire armour

Note: Manufacturing of single-phase cables with aluminium-wire armour is possible

5. Lapping layer of nonwoven cloth tape

6. Polyethylene outer sheath

Note: Conductor twisting is not illustrated