



## АПВЗКП 3x35 (ож)-1 ТУ У 31.3-00214534-016-2003

Power cables with aluminium conductors, XLPE-insulated, with filling of intermediate spaces between the conductors, round-steel-wire armoured, with polyethylene outer sheath

Cables are used for laying:

- in premises, tunnels, collectors, in soil (trenches), in corrosive environment
- in places, where intense tensile forces are possible (in cable lifting, in bulk, heaving, boggy, everfrost soils)
- in water at depth up to 10 m

Manufacturing of cables with a different number and different design of conductors is possible  
 Manufacturing of single-phase cables with aluminium-wire armour is possible

Fire safety code in accordance with ДСТУ 4809:2007: ПБ100000000

Products of this mark meet the requirements:

- single wire cable flame retardance

### TECHNICAL SPECIFICATIONS

Rated voltage	kV	1
Number and rated area of conductors	mm <sup>2</sup>	3 x 35
Phase insulation thickness	mm	0.9
Armor wire diameter	mm	1.8
Permissible continuous current rating (AC of industrial frequency) *		
• by aerial laying	A	134
• by burial	A	135
Maximum permissible conductor temperature		
• Continuous	°C	+90
• at short circuit	°C	+250
Operating temperature range	°C	-60 ... +50
Minimum bending radius by laying	mm	232
Rated outer diameter of the cable (for reference) **	mm	29
Cable weight (approximate)	kg/km	2220
Rated factory cable length and gross weight of the delivery on the drums	m, t	# 14: 700 • 1.7

Notes:

When ordering it is necessary to agree the factory length of the product with the manufacturer

\* Long permissible current loads are calculated for the following conditions: air temperature plus 25 °C, soil temperature plus 15 °C, thermal resistivity of soil 1.2 °K·m/W, laying depth in the soil 0.7 m

\*\* The external diameter may differ from the rated up to ± 10 %



## АПВЗКП 3x35 (ож)-1 ТУ У 31.3-00214534-016-2003

Power cables with aluminium conductors, XLPE-insulated, with filling of intermediate spaces between the conductors, round-steel-wire armoured, with polyethylene outer sheath

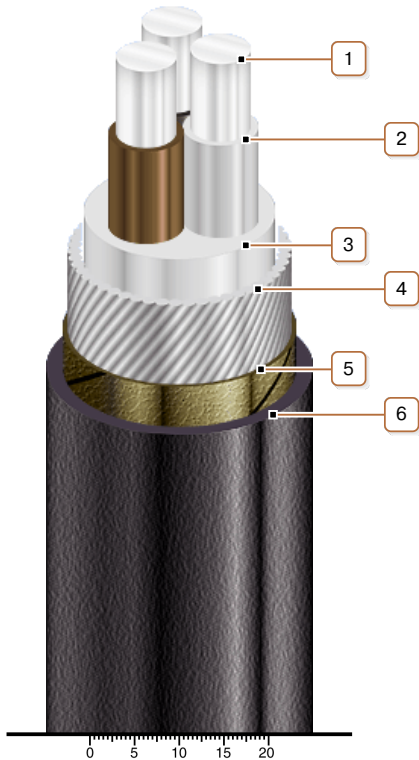

### CONSTRUCTION

1. Aluminium conductor
2. XLPE insulation
3. PVC compound belt insulation
4. Round galvanized steel-wire armour  
*Note: Manufacturing of single-phase cables with aluminium-wire armour is possible*
5. Lapping layer of nonwoven cloth tape
6. Polyethylene outer sheath

*Note: Conductor twisting is not illustrated*