



ПВЗКП 4x95-1 TY Y 31.3-00214534-016-2003

Power cables with copper conductors, XLPE-insulated, with filling of intermediate spaces between the conductors, round-steel-wire armoured, with polyethylene outer sheath

Cables are used for laying:

- in premises, tunnels, collectors, in soil (trenches), in corrosive environment
- in places, where intense tensile forces are possible (in cable lifting, in bulk, heaving, boggy, everfrost soils)
- in water at depth up to 10 m

Manufacturing of cables with a different number and different design of conductors is possible
 Manufacturing of single-phase cables with aluminium-wire armour is possible

Fire safety code in accordance with ДСТУ 4809:2007: ПБ100000000

Products of this mark meet the requirements:

- single wire cable flame retardance

TECHNICAL SPECIFICATIONS

Rated voltage	kV	1
Number and rated area of conductors	mm ²	4 x 95
Phase insulation thickness	mm	1.1
Armor wire diameter	mm	2.2
Permissible continuous current rating (AC of industrial frequency) *		
• by aerial laying	A	304
• by burial	A	282
Maximum permissible conductor temperature		
• Continuous	°C	+90
• at short circuit	°C	+250
Operating temperature range	°C	-60 ... +50
Minimum bending radius by laying	mm	360
Rated outer diameter of the cable (for reference) **	mm	45
Cable weight (approximate)	kg/km	6010
Rated factory cable length and gross weight of the delivery on the drums	m, t	# 16a: 480 • 3.1 # 18: 550 • 3.8 # 20: 870 • 5.9

Notes:

When ordering it is necessary to agree the factory length of the product with the manufacturer

* Long permissible current loads are calculated during operation in four-wire networks with load in all the conductors for the following conditions: air temperature plus 25 °C, soil temperature plus 15 °C, thermal resistivity of soil 1.2 °K·m/W, laying depth in the soil 0.7 m

** The external diameter may differ from the rated up to ± 10 %



ПВЗКП 4x95-1
ТУ У 31.3-00214534-016-2003

Power cables with copper conductors, XLPE-insulated, with filling of intermediate spaces between the conductors, round-steel-wire armoured, with polyethylene outer sheath

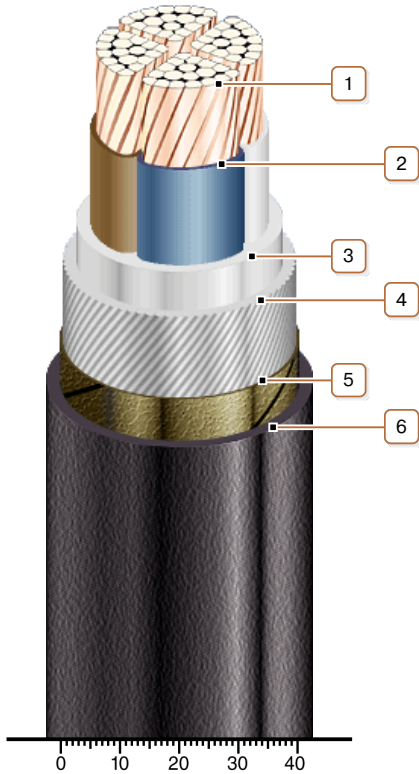

CONSTRUCTION

1. Copper multiwire compact conductor
2. XLPE insulation
3. PVC compound belt insulation
4. Round galvanized steel-wire armour
Note: Manufacturing of single-phase cables with aluminium-wire armour is possible
5. Lapping layer of nonwoven cloth tape
6. Polyethylene outer sheath

Note: Conductor twisting is not illustrated