

## АПВКВ 4x95-1 ТУ У 31.3-00214534-016-2003

Power cables with aluminium conductors, XLPE-insulated, galvanized steel-wire armoured, with PVC-compound outer sheath

Cables are used for laying:

- *single laying*
- *in premises, dry ducts and tunnels, in corrosive environment*
- *in places, where intense tensile forces are possible (in cable lifting, in bulk, heaving, boggy, everfrost soils)*

Manufacturing of cables with a different number and different design of conductors is possible  
 Manufacturing of single-phase cables with aluminium-wire armour is possible

Fire safety code in accordance with ДСТУ 4809:2007: ПБ100000000

Products of this mark meet the requirements:

- *single wire cable flame retardance*

### TECHNICAL SPECIFICATIONS

Rated voltage	kV	1
Number and rated area of conductors	mm <sup>2</sup>	4 x 95
Phase insulation thickness	mm	1.1
Armor wire diameter	mm	2.2
Permissible continuous current rating (AC of industrial frequency) *		
• <i>by aerial laying</i>	A	230
• <i>by burial</i>	A	216
Maximum permissible conductor temperature		
• <i>Continuous</i>	°C	+90
• <i>at short circuit</i>	°C	+250
Operating temperature range	°C	-50 ... +50
Minimum bending radius by laying	mm	360
Rated outer diameter of the cable (for reference) **	mm	45
Cable weight (approximate)	kg/km	3710
Rated factory cable length and gross weight of the delivery on the drums	m, t	# 16a: 480 • 2.0 # 18: 550 • 2.5 # 20: 870 • 3.9

Notes:

*When ordering it is necessary to agree the factory length of the product with the manufacturer*

*\* Long permissible current loads are calculated during operation in four-wire networks with load in all the conductors for the following conditions: air temperature plus 25 °C, soil temperature plus 15 °C, thermal resistivity of soil 1.2 °K·m/W, laying depth in the soil 0.7 m*

*\*\* The external diameter may differ from the rated up to ± 10 %*



## АПВКВ 4x95-1 ТУ У 31.3-00214534-016-2003

Power cables with aluminium conductors, XLPE-insulated, galvanized steel-wire armoured, with PVC-compound outer sheath

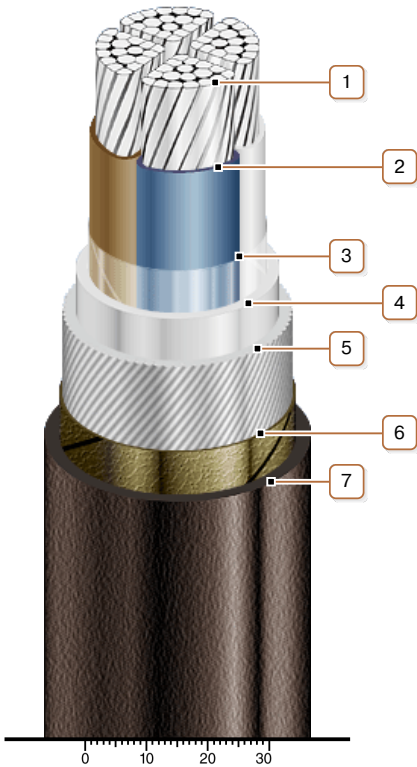

### CONSTRUCTION

1. Aluminium multiwire compacted conductor

2. XLPE insulation

3. PET film winding

4. PVC compound belt insulation

5. Round galvanized steel-wire armour

*Note: Manufacturing of single-phase cables with aluminium-wire armour is possible*

6. Lapping layer of nonwoven cloth tape

7. PVC compound outer sheath

*Note: Conductor twisting is not illustrated*