



ABKB 4x95-1 TY Y 31.3-00214534-016-2003

Power cables with aluminium conductors, with PVC-compound insulation, galvanized steel-wire armoured, with PVC-compound outer sheath

Cables are used for laying:

- *single laying*
- *in premises, dry ducts and tunnels, in corrosive environment*
- *in places, where intense tensile forces are possible (in cable lifting, in bulk, heaving, boggy, everfrost soils)*

Manufacturing of cables with a different number and different design of conductors is possible
 Manufacturing of single-phase cables with aluminium-wire armour is possible

Fire safety code in accordance with ДСТУ 4809:2007: ПБ100000000

Products of this mark meet the requirements:

- *single wire cable flame retardance*

TECHNICAL SPECIFICATIONS

| | | |
|--|-----------------|------------------------------------|
| Rated voltage | kV | 1 |
| Number and rated area of conductors | mm ² | 4 x 95 |
| Phase insulation thickness | mm | 1.6 |
| Armor wire diameter | mm | 2.2 |
| Permissible continuous current rating (AC of industrial frequency) * | | |
| • <i>by aerial laying</i> | A | 183 |
| • <i>by burial</i> | A | 199 |
| Maximum permissible conductor temperature | | |
| • <i>Continuous</i> | °C | +70 |
| • <i>at short circuit</i> | °C | +160 |
| Operating temperature range | °C | -50 ... +50 |
| Minimum bending radius by laying | mm | 376 |
| Rated outer diameter of the cable (for reference) ** | mm | 47 |
| Cable weight (approximate) | kg/km | 4030 |
| Rated factory cable length and gross weight of the delivery on the drums | m, t | # 18: 500 • 2.5 # 20: 800 • 3.9 |

Notes:

When ordering it is necessary to agree the factory length of the product with the manufacturer

** Long permissible current loads are calculated during operation in four-wire networks with load in all the conductors for the following conditions: air temperature plus 25 °C, soil temperature plus 15 °C, thermal resistivity of soil 1.2 °K·m/W, laying depth in the soil 0.7 m*

*** The external diameter may differ from the rated up to ± 10 %*



ABKB 4x95-1 TY Y 31.3-00214534-016-2003

Power cables with aluminium conductors, with PVC-compound insulation, galvanized steel-wire armoured, with PVC-compound outer sheath

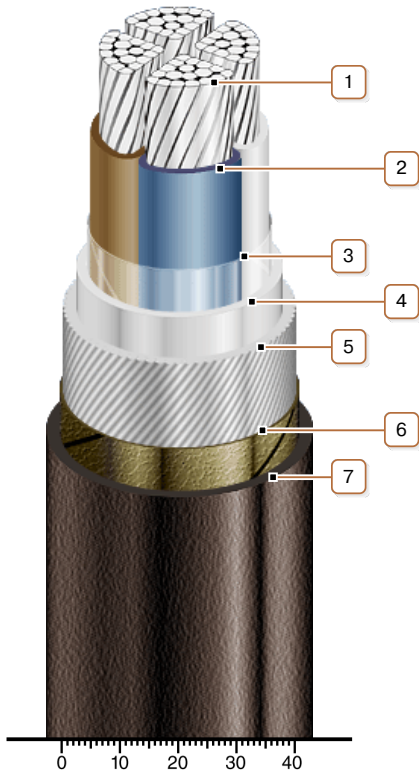

CONSTRUCTION

1. Aluminium multiwire compacted conductor

2. PVC compound insulation

3. PET film winding

4. PVC compound belt insulation

5. Round galvanized steel-wire armour

Note: Manufacturing of single-phase cables with aluminium-wire armour is possible

6. Lapping layer of nonwoven cloth tape

7. PVC compound outer sheath

Note: Conductor twisting is not illustrated