

## BKB 4x95-1 TY Y 31.3-00214534-016-2003

Power cables with copper conductors, with PVC-compound insulation, galvanized steel-wire armoured, with PVC-compound outer sheath

Cables are used for laying:

- *single laying*
- *in premises, dry ducts and tunnels, in corrosive environment*
- *in places, where intense tensile forces are possible (in cable lifting, in bulk, heaving, boggy, everfrost soils)*

Manufacturing of cables with a different number and different design of conductors is possible  
 Manufacturing of single-phase cables with aluminium-wire armour is possible

Fire safety code in accordance with ДСТУ 4809:2007: ПБ100000000

Products of this mark meet the requirements:

- *single wire cable flame retardance*

### TECHNICAL SPECIFICATIONS

Rated voltage	kV	1
Number and rated area of conductors	mm <sup>2</sup>	4 x 95
Phase insulation thickness	mm	1.6
Armor wire diameter	mm	2.2
Permissible continuous current rating (AC of industrial frequency) *		
• <i>by aerial laying</i>	A	242
• <i>by burial</i>	A	259
Maximum permissible conductor temperature		
• <i>Continuous</i>	°C	+70
• <i>at short circuit</i>	°C	+160
Operating temperature range	°C	-50 ... +50
Minimum bending radius by laying	mm	376
Rated outer diameter of the cable (for reference) **	mm	47
Cable weight (approximate)	kg/km	6370
Rated factory cable length and gross weight of the delivery on the drums	m, t	# 18: 500 • 3.6 # 20: 800 • 5.7

Notes:

*When ordering it is necessary to agree the factory length of the product with the manufacturer*

*\* Long permissible current loads are calculated during operation in four-wire networks with load in all the conductors for the following conditions: air temperature plus 25 °C, soil temperature plus 15 °C, thermal resistivity of soil 1.2 °K·m/W, laying depth in the soil 0.7 m*

*\*\* The external diameter may differ from the rated up to ± 10 %*

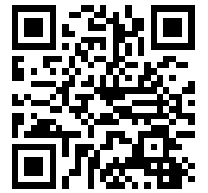

**BKB 4x95-1**  
**TY Y 31.3-00214534-016-2003**

Power cables with copper conductors, with PVC-compound insulation, galvanized steel-wire armoured, with PVC-compound outer sheath

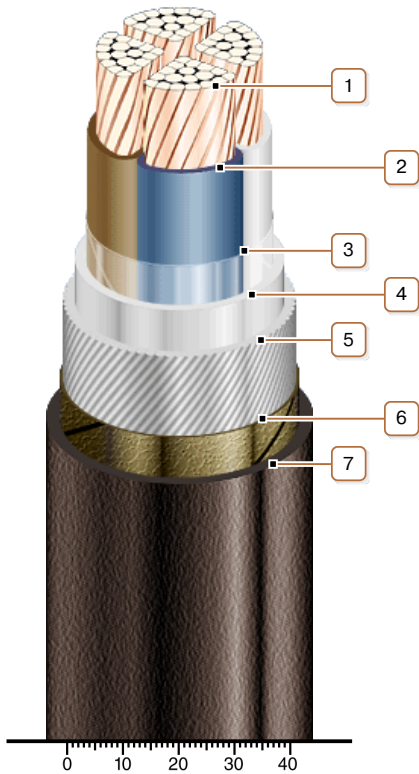

**CONSTRUCTION**

1. Copper multiwire compact conductor
2. PVC compound insulation
3. PET film winding
4. PVC compound belt insulation
5. Round galvanized steel-wire armour  
*Note: Manufacturing of single-phase cables with aluminium-wire armour is possible*
6. Lapping layer of nonwoven cloth tape
7. PVC compound outer sheath

*Note: Conductor twisting is not illustrated*