

ПвБВнгд 2х35-1 ТУ У 31.3-00214534-018-2003

Power cables with copper conductors, XLPE-insulated, galvanized steel-tape armoured, with low fire-risk PVC-compound outer sheath

Cables are used for laying:

- in bunches
- in premises, dry ducts and tunnels, in corrosive environment
- in places, where small mechanical impacts on cable are possible, including tensile forces
- in bunches, in crowded places

Manufacturing of cable with multiwire conductors is possible

Fire safety code in accordance with ДСТУ 4809:2007: ПБ123121000

Products of this mark meet the requirements:

- single wire cable flame retardance
- bunched cable flame retardance category A
- toxicity class Tk3 of the combustion products of nonmetallic elements (toxicity index over 120 g/m³)
- class ДТк1 on smoke-forming ability by smouldering of non-metallic elements (coefficient of smoke formation from 50 to 500 m²/kg)
- class ДПк2 on smoke-forming ability by combustion (minimum luminous flux more than 60 %)
- corrosive class Кк1 of combustion products of non-metallic elements (the number of halogen hydrides less than 150 mg/g, pH less than 4.3, specific conductivity more than 10 μS/mm)

TECHNICAL SPECIFICATIONS

Rated voltage	kV	1
Number and rated area of conductors	mm ²	2 x 35
Phase insulation thickness	mm	0.9
Permissible continuous current rating (AC of industrial frequency) *		
• by aerial laying	A	172
• by burial	A	173
Maximum permissible conductor temperature		
• Continuous	°C	+90
• in emergency operation	°C	+130
• at short circuit	°C	+250
Operating temperature range	°C	-50 ... +50
Minimum bending radius by laying	mm	195
Rated outer diameter of the cable (for reference) **	mm	26
Cable weight (approximate)	kg/km	1420
Rated factory cable length and gross weight of the delivery on the drums	m, t	# 14: 930 • 1.5

Notes:

When ordering it is necessary to agree the factory length of the product with the manufacturer

* Long permissible current loads are calculated for the following conditions: air temperature plus 25 °C, soil temperature plus 15 °C, thermal resistivity of soil 1.2 °K·m/W, laying depth in the soil 0.7 m

** The external diameter may differ from the rated up to ± 10 %



ПвБВнгд 2х35-1 ТУ У 31.3-00214534-018-2003

Power cables with copper conductors, XLPE-insulated, galvanized steel-tape armoured, with low fire-risk PVC-compound outer sheath

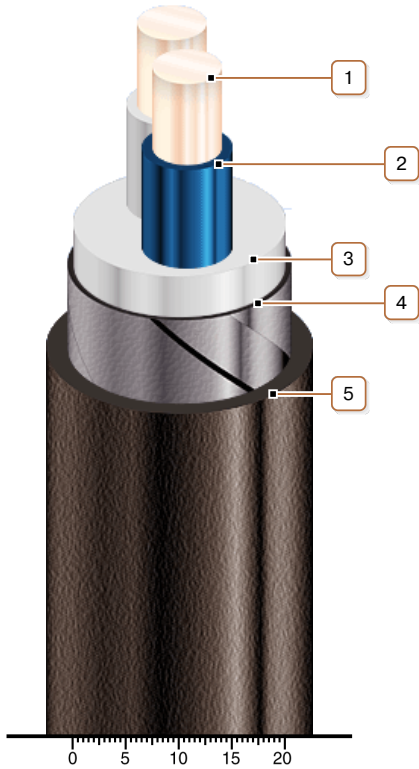

CONSTRUCTION

1. Copper conductor
2. XLPE insulation
3. Low fire-risk PVC-compound inner sheath
4. Double galvanized steel-tape armour
5. Low fire-risk PVC compound outer sheath

Note: Conductor twisting is not illustrated