

ПВБШВ 3x95-1 ГОСТ 16442-80, ТУ У 31.3-00214534-048:2007

Power cables with copper conductors, XLPE-insulated, galvanized steel-tape armoured, with PVC-compound protection hose

Cables are used for laying:

- *single laying*
- *in premises, dry ducts and tunnels, in corrosive environment*
- *in places, where small mechanical impacts on cable are possible, including tensile forces*

Manufacturing of non-galvanized armoured cable, covered with a layer of bitumen and PET film is possible
 Manufacturing of cable with PVC compound belt insulation is possible

Fire safety code in accordance with ДСТУ 4809:2007: ПБ100000000

Products of this mark meet the requirements:

- *single wire cable flame retardance*

TECHNICAL SPECIFICATIONS

Rated voltage	kV	1
Number and rated area of conductors	mm ²	3 x 95
Phase insulation thickness	mm	1.1
Permissible continuous current rating (AC of industrial frequency) *		
• <i>by aerial laying</i>	A	327
• <i>by burial</i>	A	304
Maximum permissible conductor temperature		
• <i>Continuous</i>	°C	+90
• <i>in emergency operation</i>	°C	+130
• <i>at short circuit</i>	°C	+250
Operating temperature range	°C	-50 ... +50
Minimum bending radius by laying	mm	262.5
Rated outer diameter of the cable (for reference) **	mm	35
Cable weight (approximate)	kg/km	3380
Rated factory cable length and gross weight of the delivery on the drums	m, t	# 16a: 780 • 2.9 # 18: 890 • 3.5

Notes:

When ordering it is necessary to agree the factory length of the product with the manufacturer

** Long permissible current loads are calculated for the following conditions: air temperature plus 25 °C, soil temperature plus 15 °C, thermal resistivity of soil 1.2 °K·m/W, laying depth in the soil 0.7 m*

*** The external diameter may differ from the rated up to ± 10 %*

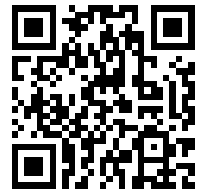

ПВБШВ 3x95-1
ГОСТ 16442-80, ТУ У 31.3-00214534-048:2007

Power cables with copper conductors, XLPE-insulated, galvanized steel-tape armoured, with PVC-compound protection hose

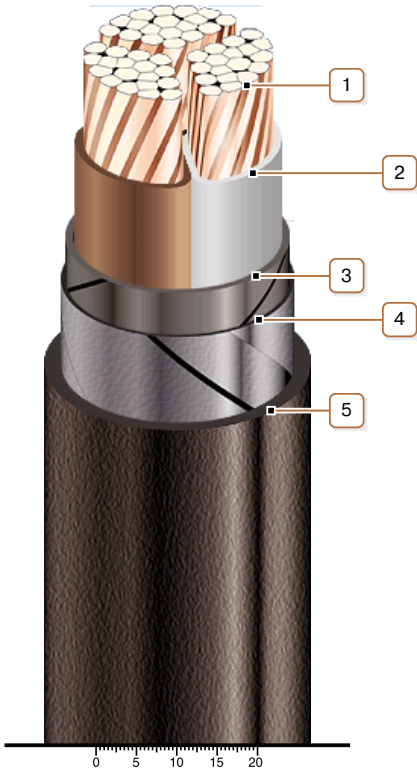

CONSTRUCTION

1. Copper multiwire compact conductor
2. XLPE insulation
3. Tape core wrapping
4. Double galvanized steel-tape armour
5. Pressed PVC compound protection hose

Note: Conductor twisting is not illustrated