

ПБПнг-НФ 2х35-1 ТУ У 31.3-00214534-069:2012

Power cables with copper conductors, with halogen-free polymer compound insulation, galvanized steel-tape armoured, with polymer compound outer sheath, flame-retardant, halogen-free

Cables are used for laying:

- in places, where small mechanical impacts on cable are possible, including tensile forces
- power supply cable lines of NPP electric equipment, wiring in office premises, which are computerized and intelligent, in kindergartens, schools, hospitals and for cable lines of spectating complexes and sport structures

Manufacturing of cable with multiwire conductors is possible

Fire safety code in accordance with ДСТУ 4809:2007: ПБ123122000

Products of this mark meet the requirements:

- single wire cable flame retardance
- bunched cable flame retardance category A
- toxicity class Tk3 of the combustion products of nonmetallic elements (toxicity index over 120 g/m³)
- class ДТк1 on smoke-forming ability by smouldering of non-metallic elements (coefficient of smoke formation from 50 to 500 m²/kg)
- class ДПк2 on smoke-forming ability by combustion (minimum luminous flux more than 60 %)
- corrosive class Kk2 of combustion products of non-metallic elements (the number of halogen hydrides less than 150 mg/g, pH more than 4.3, specific conductivity less than 10 μS/mm)

TECHNICAL SPECIFICATIONS

Rated voltage	kV	1
Number and rated area of conductors	mm ²	2 x 35
Phase insulation thickness	mm	1.2
Permissible continuous current rating (AC of industrial frequency) *		
• by aerial laying	A	137
Maximum permissible conductor temperature		
• Continuous	°C	+70
• in emergency operation	°C	+90
• at short circuit	°C	+160
Operating temperature range	°C	-50 ... +50
Minimum bending radius by laying	mm	202.5
Rated outer diameter of the cable (for reference) **	mm	27
Cable weight (approximate)	kg/km	1520
Rated factory cable length and gross weight of the delivery on the drums	m, t	# 14: 800 • 1.4

Notes:

When ordering it is necessary to agree the factory length of the product with the manufacturer

* Long permissible current loads are calculated for the following conditions: air temperature plus 25 °C, soil temperature plus 15 °C, thermal resistivity of soil 1.2 °K·m/W, laying depth in the soil 0.7 m

** The external diameter may differ from the rated up to ± 10 %



ПБПнг-НФ 2х35-1 ТУ У 31.3-00214534-069:2012

Power cables with copper conductors, with halogen-free polymer compound insulation, galvanized steel-tape armoured, with polymer compound outer sheath, flame-retardant, halogen-free

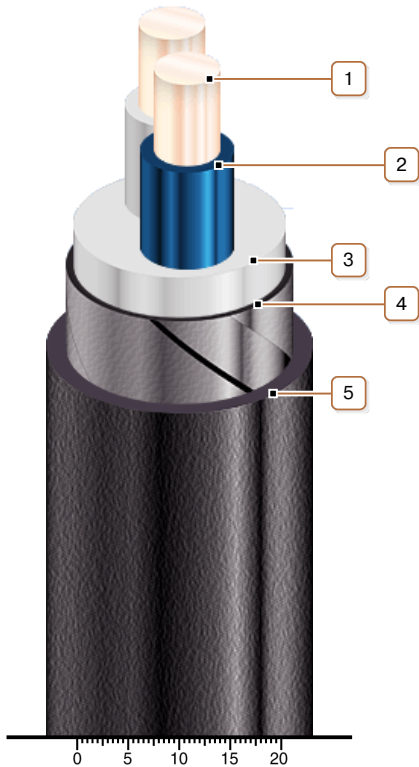

CONSTRUCTION

1. Copper conductor
2. Halogen-free polymer compound insulation
3. Halogen-free polymer compound inner sheath
4. Double galvanized steel-tape armour
5. Polymer compound outer sheath: flame-retardant and halogen-free

Note: Conductor twisting is not illustrated