



АВВГзнг 3х16 (ож)-1 ТУ У 31.3-00214534-018-2003

Power cables with aluminium conductors, with PVC-compound insulation, with low-flammable PVC-compound outer sheath

Cables are used for laying:

- *in bunches*
- *in premises, dry ducts and tunnels, in corrosive environment*

Fire safety code in accordance with ДСТУ 4809:2007: ПБ120000000

Products of this mark meet the requirements:

- *single wire cable flame retardance*
- *bunched cable flame retardance category A*

TECHNICAL SPECIFICATIONS

Rated voltage	kV	1
Number and rated area of conductors	mm ²	3 x 16
Phase insulation thickness	mm	1
Permissible continuous current rating (AC of industrial frequency) *		
• <i>by aerial laying</i>	A	67
• <i>by burial</i>	A	77
Maximum permissible conductor temperature		
• <i>Continuous</i>	°C	+70
• <i>in emergency operation</i>	°C	+90
• <i>at short circuit</i>	°C	+160
Operating temperature range	°C	-50 ... +50
Minimum bending radius by laying	mm	135
Rated outer diameter of the cable (for reference) **	mm	18
Cable weight (approximate)	kg/km	390
Rated factory cable length and gross weight of the delivery on the drums	m, t	# 12: 1010 • 0.5

Notes:

When ordering it is necessary to agree the factory length of the product with the manufacturer

* *Long permissible current loads are calculated for the following conditions: air temperature plus 25 °C, soil temperature plus 15 °C, thermal resistivity of soil 1.2 °K·m/W, laying depth in the soil 0.7 m*

** *The external diameter may differ from the rated up to ± 10 %*



АВВГзнг 3х16 (ож)-1 ТУ У 31.3-00214534-018-2003

Power cables with aluminium conductors, with PVC-compound insulation, with low-flammable PVC-compound outer sheath

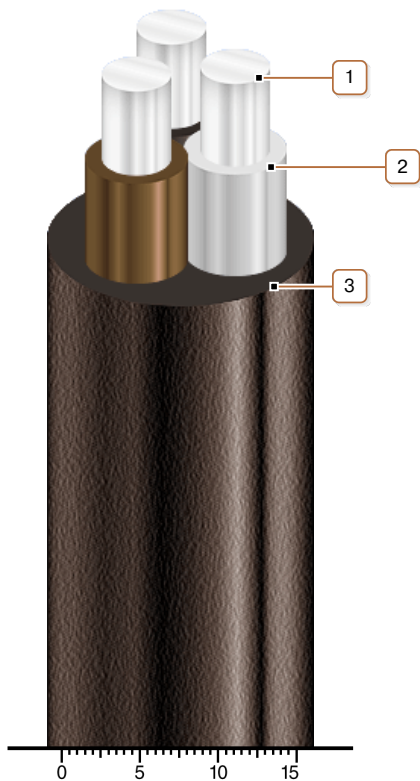

CONSTRUCTION

1. Aluminium conductor
2. PVC compound insulation
3. Low flammable PVC compound outer sheath

Note: Conductor twisting is not illustrated