



## АВБбШнгд 3х6+1х4 (ож)-1 ТУ У 31.3-00214534-018-2003

Power cables with aluminium conductors, with low-flammable PVC-compound insulation, galvanized steel-tape armoured, with PVC-compound protection hose

Cables are used for laying:

- in bunches
- in premises, dry ducts and tunnels, in corrosive environment
- in places, where small mechanical impacts on cable are possible, including tensile forces
- in bunches, in crowded places

Fire safety code in accordance with ДСТУ 4809:2007: ПБ123121000

Products of this mark meet the requirements:

- single wire cable flame retardance
- bunched cable flame retardance category A
- toxicity class Tk3 of the combustion products of nonmetallic elements (toxicity index over 120 g/m<sup>3</sup>)
- class ДТк1 on smoke-forming ability by smouldering of non-metallic elements (coefficient of smoke formation from 50 to 500 m<sup>2</sup>/kg)
- class ДПк2 on smoke-forming ability by combustion (minimum luminous flux more than 60 %)
- corrosive class Kk1 of combustion products of non-metallic elements (the number of halogen hydrides less than 150 mg/g, pH less than 4.3, specific conductivity more than 10 μS/mm)

### TECHNICAL SPECIFICATIONS

Rated voltage	kV	1
Number and rated area of conductors	mm <sup>2</sup>	3 x 6 + 1 x 4
Phase insulation thickness	mm	1
Permissible continuous current rating (AC of industrial frequency) *		
• by aerial laying	A	37
• by burial	A	44
Maximum permissible conductor temperature		
• Continuous	°C	+70
• in emergency operation	°C	+80
• at short circuit	°C	+130
Operating temperature range	°C	-50 ... +50
Minimum bending radius by laying	mm	157.5
Rated outer diameter of the cable (for reference) **	mm	21
Cable weight (approximate)	kg/km	640
Rated factory cable length and gross weight of the delivery on the drums ***	m, t	# 14: 1300 • 1.0

Notes:

When ordering it is necessary to agree the factory length of the product with the manufacturer

\* Long permissible current loads are calculated for the following conditions: air temperature plus 25 °C, soil temperature plus 15 °C, thermal resistivity of soil 1.2 °K·m/W, laying depth in the soil 0.7 m

\*\* The external diameter may differ from the rated up to ± 10 %



## АВБбШнгд 3х6+1х4 (ож)-1 ТУ У 31.3-00214534-018-2003

Power cables with aluminium conductors, with low-flammable PVC-compound insulation, galvanized steel-tape armoured, with PVC-compound protection hose

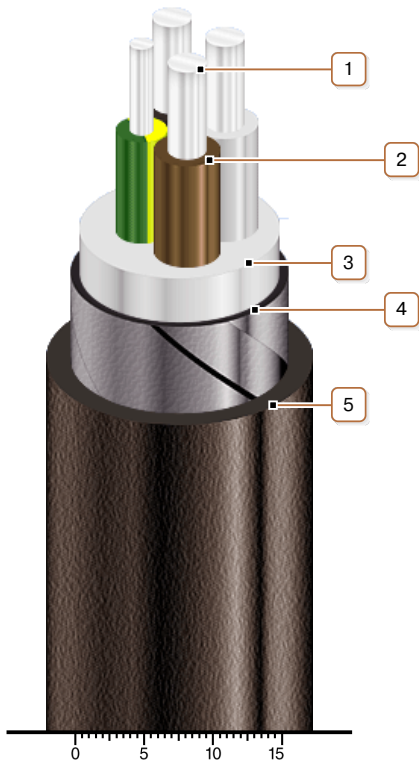

### CONSTRUCTION

1. Aluminium conductor
2. Low fire-risk PVC compound insulation
3. Low fire-risk PVC-compound inner sheath
4. Double galvanized steel-tape armour
5. Pressed off low fire-risk PVC compound protection hose

Note: Conductor twisting is not illustrated