



ВБШнг 3х35-1 ТУ У 31.3-00214534-018-2003

Power cables with copper conductors, with PVC-compound insulation, galvanized steel-tape armoured, with low-flammable PVC-compound protection hose

Cables are used for laying:

- *in bunches*
- *in premises, dry ducts and tunnels, in corrosive environment*
- *in places, where small mechanical impacts on cable are possible, including tensile forces*

Manufacturing of cable with multiwire conductors is possible

Manufacturing of cable with tape belt insulation is possible

Fire safety code in accordance with ДСТУ 4809:2007: ПБ120000000

Products of this mark meet the requirements:

- *single wire cable flame retardance*
- *bunched cable flame retardance category A*

TECHNICAL SPECIFICATIONS

Rated voltage	kV	1
Number and rated area of conductors	mm ²	3 x 35
Phase insulation thickness	mm	1.2
Permissible continuous current rating (AC of industrial frequency) *		
• <i>by aerial laying</i>	A	137
• <i>by burial</i>	A	158
Maximum permissible conductor temperature		
• <i>Continuous</i>	°C	+70
• <i>in emergency operation</i>	°C	+90
• <i>at short circuit</i>	°C	+160
Operating temperature range	°C	-50 ... +50
Minimum bending radius by laying	mm	210
Rated outer diameter of the cable (for reference) **	mm	28
Cable weight (approximate)	kg/km	1520
Rated factory cable length and gross weight of the delivery on the drums ***	m, t	# 14: 800 • 1.4

Notes:

When ordering it is necessary to agree the factory length of the product with the manufacturer

** Long permissible current loads are calculated for the following conditions: air temperature plus 25 °C, soil temperature plus 15 °C, thermal resistivity of soil 1.2 °K·m/W, laying depth in the soil 0.7 m*

*** The external diameter may differ from the rated up to ± 10 %*

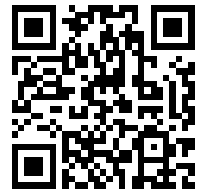

ВБШнг 3x35-1 ТУ У 31.3-00214534-018-2003

Power cables with copper conductors, with PVC-compound insulation, galvanized steel-tape armoured, with low-flammable PVC-compound protection hose

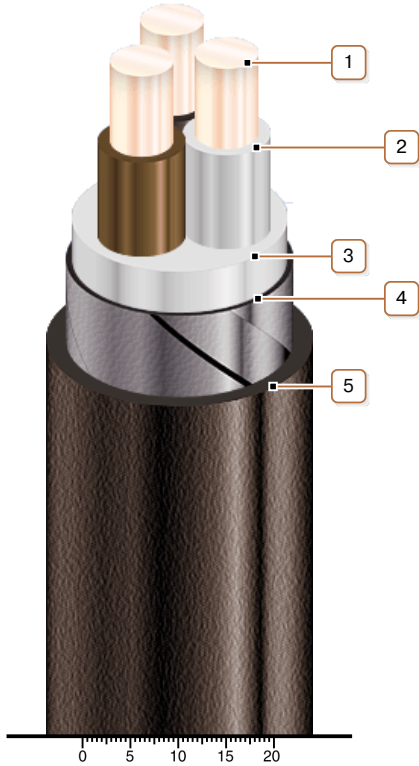

CONSTRUCTION

1. *Copper conductor*
2. *PVC compound insulation*
3. *PVC compound belt insulation*
4. *Double galvanized steel-tape armour*
5. *Pressed off low-flammable PVC compound protection hose*

Note: Conductor twisting is not illustrated