



АВБШВ 2x4 (ож)-1 ГОСТ 16442-80, ТУ У 31.3-00214534-048:2007

Power cables with aluminium conductors, with PVC-compound insulation, galvanized steel-tape armoured, with low-flammable PVC-compound protection hose

Cables are used for laying:

- *single laying*
- *in premises, dry ducts and tunnels, in corrosive environment*
- *in places, where small mechanical impacts on cable are possible, including tensile forces*

Manufacturing of non-galvanized armoured cable, covered with a layer of bitumen and PET film is possible

Fire safety code in accordance with ДСТУ 4809:2007: ПБ100000000

Products of this mark meet the requirements:

- *single wire cable flame retardance*

TECHNICAL SPECIFICATIONS

Rated voltage	kV	1
Number and rated area of conductors	mm ²	2 x 4
Phase insulation thickness	mm	1
Permissible continuous current rating (AC of industrial frequency) *		
• <i>by aerial laying</i>	A	29
• <i>by burial</i>	A	37
Maximum permissible conductor temperature		
• <i>Continuous</i>	°C	+70
• <i>in emergency operation</i>	°C	+90
• <i>at short circuit</i>	°C	+160
Operating temperature range	°C	-50 ... +50
Minimum bending radius by laying	mm	135
Rated outer diameter of the cable (for reference) **	mm	18
Cable weight (approximate)	kg/km	390
Rated factory cable length and gross weight of the delivery on the drums ***	m, t	# 12: 1010 • 0.5

Notes:

When ordering it is necessary to agree the factory length of the product with the manufacturer

** Long permissible current loads are calculated for the following conditions: air temperature plus 25 °C, soil temperature plus 15 °C, thermal resistivity of soil 1.2 °K·m/W, laying depth in the soil 0.7 m*

*** The external diameter may differ from the rated up to ± 10 %*



АВБШВ 2х4 (ож)-1 ГОСТ 16442-80,ТУ У 31.3-00214534-048:2007

Power cables with aluminium conductors, with PVC-compound insulation, galvanized steel-tape armoured, with low-flammable PVC-compound protection hose

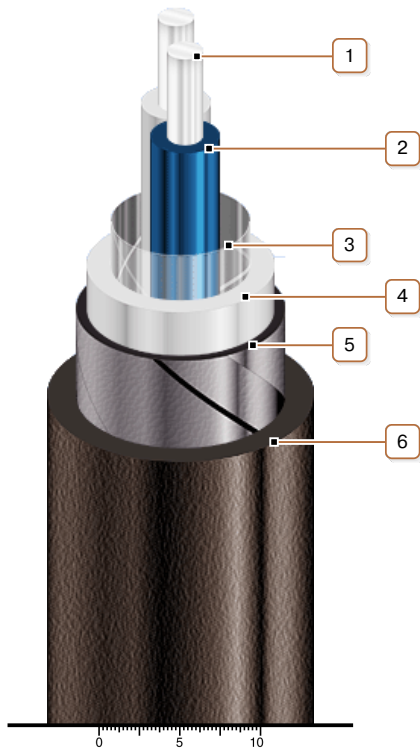

CONSTRUCTION

1. Aluminium conductor
2. PVC compound insulation
3. PET film winding
4. PVC compound belt insulation
5. Double galvanized steel-tape armour
6. Pressed PVC compound protection hose

Note: Conductor twisting is not illustrated