



СП2л 3x150-10 ТУ У 27.3-00214534-091:2017

Power cables with copper conductors, with impregnated paper insulation, lead-sheathed, steel-wire armoured

Cables are used for laying:

- *in soil (trenches) with high corrosiveness, as well as with vagabond currents*
- *with a risk of mechanical damage and tensile forces in operation*

TECHNICAL SPECIFICATIONS

Rated voltage	kV	10
Number and rated area of conductors	mm ²	3 x 150
Insulation thickness between conductors	mm	5.5
Insulation thickness of conductor-sheath	mm	4
Sheath thickness	mm	1.62
Permissible continuous current rating *		
• <i>by aerial laying</i>	A	349
• <i>by burial</i>	A	318
Operating temperature range	°C	-50 ... +50
Minimum bending radius by laying	mm	915
Level difference along the laying rout, not more than	m	15
Metal sheath outer diameter (for reference only)	mm	44
Rated outer diameter of the cable (for reference) **	mm	61
Cable weight (approximate)	kg/km	10930
Rated factory cable length and gross weight of the delivery on the drums	m, t	# 18: 270 • 3.4

Notes:

When ordering it is necessary to agree the factory length of the product with the manufacturer

* *Long permissible current loads are calculated for the following conditions: air temperature plus 25 °C, soil temperature plus 15 °C, thermal resistivity of soil 1.2 °K·m/W, laying depth in the soil 0.7 m*

** *The external diameter may differ from the rated up to ± 10 %*



СП2л 3x150-10 ТУ У 27.3-00214534-091:2017

Power cables with copper conductors, with impregnated paper insulation, lead-sheathed, steel-wire armoured

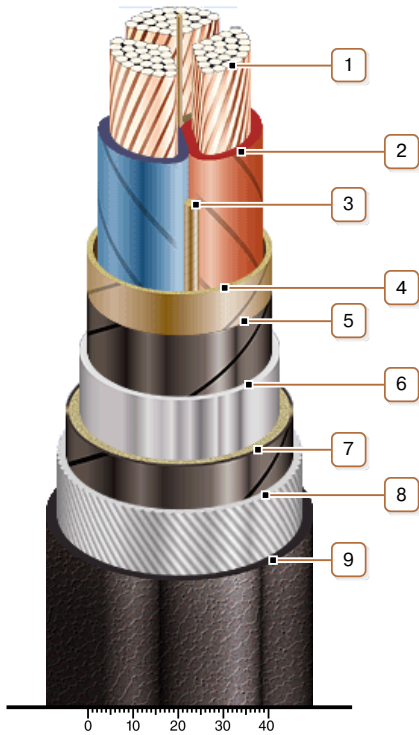

CONSTRUCTION

1. Copper multiwire compact conductor
2. Impregnated paper insulation
3. Cable paper bundle
4. Belt insulation
5. Conducting paper screen
6. Lead sheath
7. Double-layer plastic-tape bedding
8. Round galvanized steel-wire armour
9. Outer covering

Note: Conductor twisting is not illustrated