



СП2л 3x95-1 ТУ У 27.3-00214534-091:2017

Power cables with copper conductors, with impregnated paper insulation, lead-sheathed, steel-wire armoured

Cables are used for laying:

- in soil (trenches) with high corrosiveness, as well as with vagabond currents
- with a risk of mechanical damage and tensile forces in operation

TECHNICAL SPECIFICATIONS

Rated voltage	kV	1
Number and rated area of conductors	mm ²	3 x 95
Insulation thickness between conductors	mm	1.5
Insulation thickness of conductor-sheath	mm	1.25
Sheath thickness	mm	1.32
Permissible continuous current rating *		
• by aerial laying	A	301
• by burial	A	287
Operating temperature range	°C	-50 ... +50
Minimum bending radius by laying	mm	660
Level difference along the laying rout, not more than	m	20
Metal sheath outer diameter (for reference only)	mm	28
Rated outer diameter of the cable (for reference) **	mm	44
Cable weight (approximate)	kg/km	6180
Rated factory cable length and gross weight of the delivery on the drums	m, t	# 16a: 520 • 3.5 # 18: 600 • 4.2

Notes:

When ordering it is necessary to agree the factory length of the product with the manufacturer

* Long permissible current loads are calculated for the following conditions: air temperature plus 25 °C, soil temperature plus 15 °C, thermal resistivity of soil 1.2 °K·m/W, laying depth in the soil 0.7 m

** The external diameter may differ from the rated up to ± 10 %

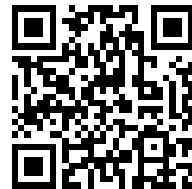

СП2л 3x95-1 ТУ У 27.3-00214534-091:2017

Power cables with copper conductors, with impregnated paper insulation, lead-sheathed, steel-wire armoured

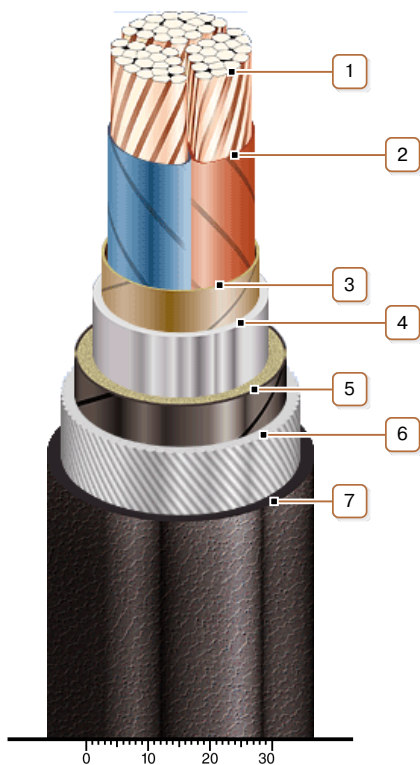

CONSTRUCTION

1. Copper multiwire compact conductor
2. Impregnated paper insulation
3. Belt insulation
4. Lead sheath
5. Double-layer plastic-tape bedding
6. Round galvanized steel-wire armour
7. Outer covering

Note: Conductor twisting is not illustrated