



## СПл 4x70-1 ТУ У 27.3-00214534-091:2017

Power cables with copper conductors, with impregnated paper insulation, lead-sheathed, steel-wire armoured

Cables are used for laying:

- *in soil (trenches) with medium corrosiveness, as well as with vagabond currents*
- *with a risk of mechanical damage and tensile forces in operation*

### TECHNICAL SPECIFICATIONS

Rated voltage	kV	1
Number and rated area of conductors	mm <sup>2</sup>	4 x 70
Insulation thickness between conductors	mm	1.5
Insulation thickness of conductor-sheath	mm	1.25
Sheath thickness	mm	1.36
Permissible continuous current rating *		
• <i>by aerial laying</i>	A	230
• <i>by burial</i>	A	224
Operating temperature range	°C	-50 ... +50
Minimum bending radius by laying	mm	705
Level difference along the laying rout, not more than	m	20
Metal sheath outer diameter (for reference only)	mm	30
Rated outer diameter of the cable (for reference) **	mm	47
Cable weight (approximate)	kg/km	6350
Rated factory cable length and gross weight of the delivery on the drums ***	m, t	# 16a: 440 • 3.1 # 18: 500 • 3.6

Notes:

*When ordering it is necessary to agree the factory length of the product with the manufacturer*

*\* Long permissible current loads are calculated during operation in four-wire networks with load in all the conductors for the following conditions: air temperature plus 25 °C, soil temperature plus 15 °C, thermal resistivity of soil 1.2 °K·m/W, laying depth in the soil 0.7 m*

*\*\* The external diameter may differ from the rated up to ± 10 %*



## СПл 4x70-1 ТУ У 27.3-00214534-091:2017

Power cables with copper conductors, with impregnated paper insulation, lead-sheathed, steel-wire armoured

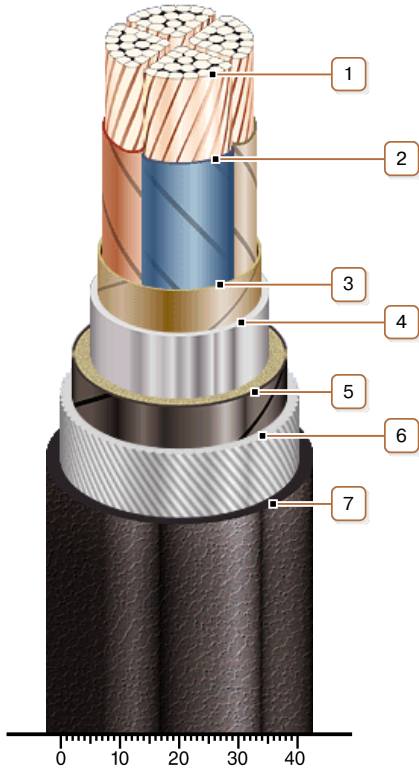

### CONSTRUCTION

1. Copper multiwire compact conductor
2. Impregnated paper insulation
3. Belt insulation
4. Lead sheath
5. Single-layer plastic-tape bedding
6. Round galvanized steel-wire armour
7. Outer covering

Note: Conductor twisting is not illustrated