



## СБл 3x70-10 ТУ У 27.3-00214534-091:2017

Power cables with copper conductors, with impregnated paper insulation, lead-sheathed, steel-tape armoured

Cables are used for laying:

- in soil (trenches) with high corrosiveness without vagabond currents
- in soil (trenches) with medium corrosiveness, as well as with vagabond currents
- in mines, non-hazardous as for gas and dust
- with a risk of mechanical damage and no tensile forces in operation

### TECHNICAL SPECIFICATIONS

Rated voltage	kV	10
Number and rated area of conductors	mm <sup>2</sup>	3 x 70
Insulation thickness between conductors	mm	5.5
Insulation thickness of conductor-sheath	mm	4
Sheath thickness	mm	1.46
Permissible continuous current rating *		
• by aerial laying	A	219
• by burial	A	212
Operating temperature range	°C	-50 ... +50
Minimum bending radius by laying	mm	705
Level difference along the laying rout, not more than	m	15
Metal sheath outer diameter (for reference only)	mm	36
Rated outer diameter of the cable (for reference) **	mm	47
Cable weight (approximate)	kg/km	5490
Rated factory cable length and gross weight of the delivery on the drums	m, t	# 16a: 440 • 2.7 # 18: 500 • 3.2

Notes:

When ordering it is necessary to agree the factory length of the product with the manufacturer

\* Long permissible current loads are calculated for the following conditions: air temperature plus 25 °C, soil temperature plus 15 °C, thermal resistivity of soil 1.2 °K·m/W, laying depth in the soil 0.7 m

\*\* The external diameter may differ from the rated up to ± 10 %



## СБл 3x70-10 ТУ У 27.3-00214534-091:2017

Power cables with copper conductors, with impregnated paper insulation, lead-sheathed, steel-tape armoured

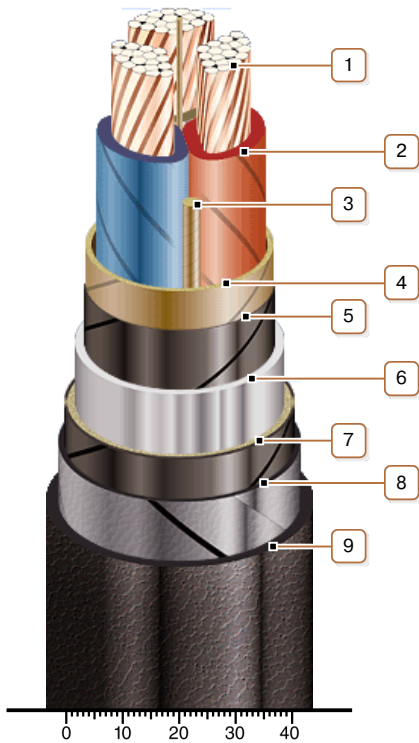

### CONSTRUCTION

1. Copper multiwire compact conductor
2. Impregnated paper insulation
3. Cable paper bundle
4. Belt insulation
5. Conducting paper screen
6. Lead sheath
7. Single-layer plastic-tape bedding
8. Double steel-tape armour
9. Outer covering

Note: Conductor twisting is not illustrated