



СБ 3x95-6 TY Y 27.3-00214534-091:2017

Power cables with copper conductors, with impregnated paper insulation, lead-sheathed, steel-tape armoured

Cables are used for laying:

- in soil (trenches) with medium corrosiveness without vagabond currents
- in soil (trenches) with low corrosiveness, as well as with vagabond currents
- in mines, non-hazardous as for gas and dust
- with a risk of mechanical damage and no tensile forces in operation

TECHNICAL SPECIFICATIONS

Rated voltage	kV	6
Number and rated area of conductors	mm ²	3 x 95
Insulation thickness between conductors	mm	4
Insulation thickness of conductor-sheath	mm	2.95
Sheath thickness	mm	1.42
Permissible continuous current rating *		
• by aerial laying	A	296
• by burial	A	280
Operating temperature range	°C	-50 ... +50
Minimum bending radius by laying	mm	690
Level difference along the laying rout, not more than	m	15
Metal sheath outer diameter (for reference only)	mm	34
Rated outer diameter of the cable (for reference) **	mm	46
Cable weight (approximate)	kg/km	6080
Rated factory cable length and gross weight of the delivery on the drums ***	m, t	# 16a: 480 • 3.2 # 18: 550 • 3.8

Notes:

When ordering it is necessary to agree the factory length of the product with the manufacturer

* Long permissible current loads are calculated for the following conditions: air temperature plus 25 °C, soil temperature plus 15 °C, thermal resistivity of soil 1.2 °K·m/W, laying depth in the soil 0.7 m

** The external diameter may differ from the rated up to ± 10 %



СБ 3x95-6
TY Y 27.3-00214534-091:2017

Power cables with copper conductors, with impregnated paper insulation, lead-sheathed, steel-tape armoured

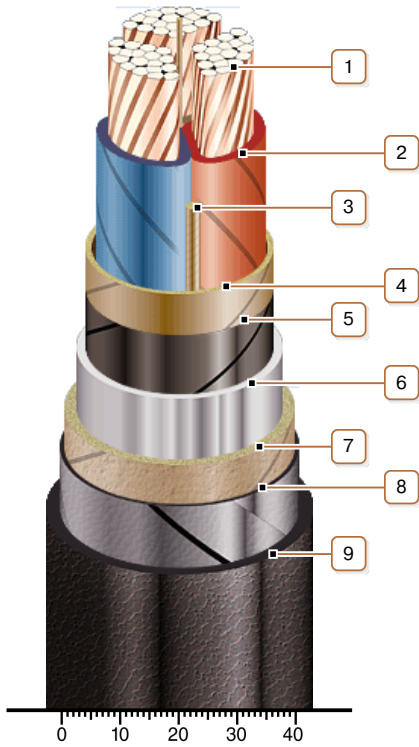

CONSTRUCTION

1. Copper multiwire compact conductor
2. Impregnated paper insulation
3. Cable paper bundle
4. Belt insulation
5. Conducting paper screen
6. Lead sheath
7. Bedding
8. Double steel-tape armour
9. Outer covering

Note: Conductor twisting is not illustrated