

АСП2л 3x95+1x50(ож)-1 ТУ У 27.3-00214534-091:2017

Power cables with aluminium conductors, with impregnated paper insulation, lead-sheathed, steel-wire armoured

Cables are used for laying:

- *in soil (trenches) with high corrosiveness, as well as with vagabond currents*
- *with a risk of mechanical damage and tensile forces in operation*

TECHNICAL SPECIFICATIONS

Rated voltage	kV	1
Number and rated area of conductors	mm ²	3 x 95 + 1 x 50
Insulation thickness between conductors	mm	1.5
Insulation thickness of conductor-sheath	mm	1.25
Sheath thickness	mm	1.32
Permissible continuous current rating *		
• <i>by aerial laying</i>	A	218
• <i>by burial</i>	A	219
Operating temperature range	°C	-50 ... +50
Minimum bending radius by laying	mm	675
Level difference along the laying rout, not more than	m	25
Metal sheath outer diameter (for reference only)	mm	29
Rated outer diameter of the cable (for reference) **	mm	45
Cable weight (approximate)	kg/km	4760
Rated factory cable length and gross weight of the delivery on the drums	m, t	# 16a: 480 • 2.5 # 18: 550 • 3.1

Notes:

When ordering it is necessary to agree the factory length of the product with the manufacturer

** Long permissible current loads are calculated for the following conditions: air temperature plus 25 °C, soil temperature plus 15 °C, thermal resistivity of soil 1.2 °K·m/W, laying depth in the soil 0.7 m*

*** The external diameter may differ from the rated up to ± 10 %*

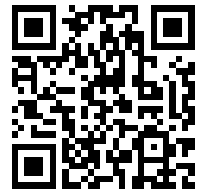

АСП2л 3x95+1x50(ож)-1 ТУ У 27.3-00214534-091:2017

Power cables with aluminium conductors, with impregnated paper insulation, lead-sheathed, steel-wire armoured

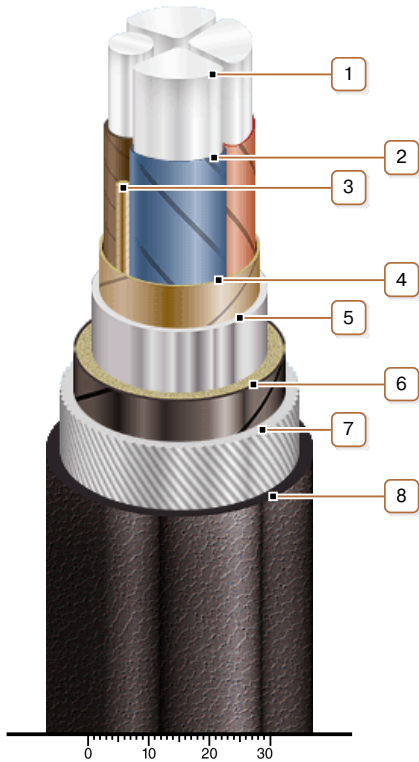

CONSTRUCTION

1. Aluminium conductor
2. Impregnated paper insulation
3. Cable paper bundle
4. Belt insulation
5. Lead sheath
6. Double-layer plastic-tape bedding
7. Round galvanized steel-wire armour
8. Outer covering

Note: Conductor twisting is not illustrated