



## АСБлШв 3х95(ож)-1 ТУ У 27.3-00214534-091:2017

Power cables with aluminium conductors, with impregnated paper insulation, lead-sheathed, steel-tape armoured, with PVC-compound protection hose

Cables are used for laying:

- in soil (trenches) with high corrosiveness without vagabond currents
- in soil (trenches) with medium corrosiveness, as well as with vagabond currents
- in fire-risk premises
- on technological trestles
- on special cable bridges
- in mines, non-hazardous as for gas and dust
- with a risk of mechanical damage and no tensile forces in operation

Fire safety code in accordance with ДСТУ 4809:2007: ПБ100000000

Products of this mark meet the requirements:

- single wire cable flame retardance

### TECHNICAL SPECIFICATIONS

Rated voltage	kV	1
Number and rated area of conductors	mm <sup>2</sup>	3 x 95
Insulation thickness between conductors	mm	1.5
Insulation thickness of conductor-sheath	mm	1.25
Sheath thickness	mm	1.26
Permissible continuous current rating *		
• by aerial laying	A	218
• by burial	A	219
Operating temperature range	°C	-50 ... +50
Minimum bending radius by laying	mm	570
Level difference along the laying rout, not more than	m	25
Metal sheath outer diameter (for reference only)	mm	26
Rated outer diameter of the cable (for reference) **	mm	38
Cable weight (approximate)	kg/km	3210
Rated factory cable length and gross weight of the delivery on the drums	m, t	# 16a: 700 • 2.5

Notes:

When ordering it is necessary to agree the factory length of the product with the manufacturer

\* Long permissible current loads are calculated for the following conditions: air temperature plus 25 °C, soil temperature plus 15 °C, thermal resistivity of soil 1.2 °K·m/W, laying depth in the soil 0.7 m

\*\* The external diameter may differ from the rated up to ± 10 %



## АСБлШв 3х95(ож)-1 ТУ У 27.3-00214534-091:2017

Power cables with aluminium conductors, with impregnated paper insulation, lead-sheathed, steel-tape armoured, with PVC-compound protection hose

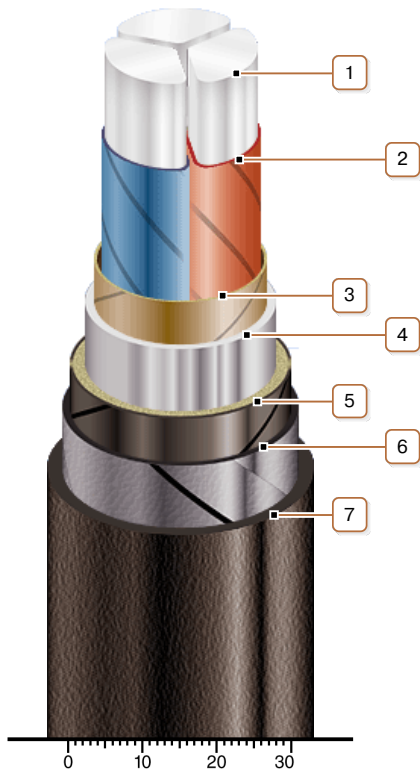

### CONSTRUCTION

1. Aluminium conductor
2. Impregnated paper insulation
3. Belt insulation
4. Lead sheath
5. Single-layer plastic-tape bedding
6. Double steel-tape armour
7. Pressed PVC compound protection hose

Note: Conductor twisting is not illustrated