



АСБ2лШв 3x35(ож)-10 ТУ У 27.3-00214534-091:2017

Power cables with aluminium conductors, with impregnated paper insulation, lead-sheathed, steel-tape armoured, with PVC-compound protection hose

Cables are used for laying:

- in soil (trenches) with high corrosiveness, as well as with vagabond currents
- in dry premises (tunnels), ducts, cable cellars, mines, collectors, industrial and other premises, including damp, partially flooded premises, environment with medium and high corrosiveness
- with a risk of mechanical damage and no tensile forces in operation

Fire safety code in accordance with ДСТУ 4809:2007: ПБ100000000

Products of this mark meet the requirements:

- single wire cable flame retardance

TECHNICAL SPECIFICATIONS

Rated voltage	kV	10
Number and rated area of conductors	mm ²	3 x 35
Insulation thickness between conductors	mm	5.5
Insulation thickness of conductor-sheath	mm	4
Sheath thickness	mm	1.32
Permissible continuous current rating *		
• by aerial laying	A	106
• by burial	A	110
Operating temperature range	°C	-50 ... +50
Minimum bending radius by laying	mm	615
Level difference along the laying rout, not more than	m	15
Metal sheath outer diameter (for reference only)	mm	28
Rated outer diameter of the cable (for reference) **	mm	41
Cable weight (approximate)	kg/km	3430
Rated factory cable length and gross weight of the delivery on the drums	m, t	# 16a: 570 • 2.2 # 18: 660 • 2.7

Notes:

When ordering it is necessary to agree the factory length of the product with the manufacturer

* Long permissible current loads are calculated for the following conditions: air temperature plus 25 °C, soil temperature plus 15 °C, thermal resistivity of soil 1.2 °K·m/W, laying depth in the soil 0.7 m

** The external diameter may differ from the rated up to ± 10 %

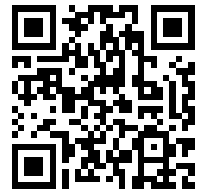

АСБ2лШв 3x35(ож)-10 ТУ У 27.3-00214534-091:2017

Power cables with aluminium conductors, with impregnated paper insulation, lead-sheathed, steel-tape armoured, with PVC-compound protection hose

CONSTRUCTION

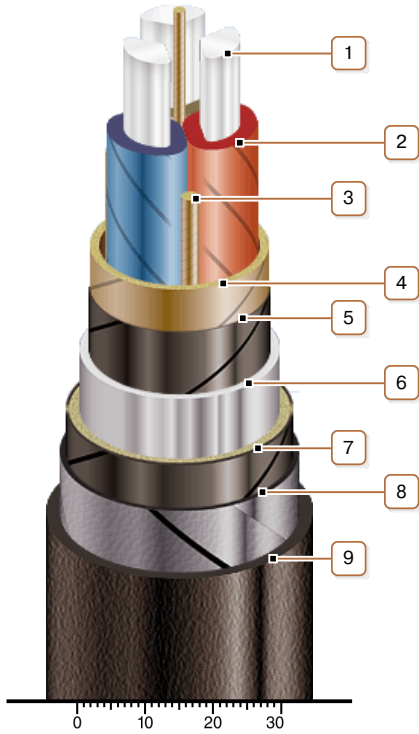

1. Aluminium conductor
2. Impregnated paper insulation
3. Cable paper bundle
4. Belt insulation
5. Conducting paper screen
6. Lead sheath
7. Double-layer plastic-tape bedding
8. Double steel-tape armour
9. Pressed PVC compound protection hose

Note: Conductor twisting is not illustrated