



## АСБ2лШв 1x400-3 ТУ У 27.3-00214534-091:2017

Power cables with aluminium conductors, with impregnated paper insulation, lead-sheathed, steel-tape armoured, with PVC-compound protection hose

Cables are used for laying:

- in soil (trenches) with high corrosiveness, as well as with vagabond currents
- in dry premises (tunnels), ducts, cable cellars, mines, collectors, industrial and other premises, including damp, partially flooded premises, environment with medium and high corrosiveness
- with a risk of mechanical damage and no tensile forces in operation

Fire safety code in accordance with ДСТУ 4809:2007: ПБ100000000

Products of this mark meet the requirements:

- single wire cable flame retardance

### TECHNICAL SPECIFICATIONS

Rated voltage	kV	3
Number and rated area of conductors	mm <sup>2</sup>	1 x 400
Insulation thickness of conductor-sheath	mm	2.3
Sheath thickness	mm	1.36
Permissible continuous direct current rating *		
• by aerial laying	A	838
• by burial	A	663
Operating temperature range	°C	-50 ... +50
Minimum bending radius by laying	mm	1075
Level difference along the laying route, not more than	m	25
Metal sheath outer diameter (for reference only)	mm	31
Rated outer diameter of the cable (for reference) **	mm	43
Cable weight (approximate)	kg/km	4330
Rated factory cable length and gross weight of the delivery on the drums ***	m, t	# 18: 600 • 3.1

Notes:

When ordering it is necessary to agree the factory length of the product with the manufacturer

\* Long permissible current loads are calculated for the following conditions: air temperature plus 25 °C, soil temperature plus 15 °C, thermal resistivity of soil 1.2 °K·m/W, laying depth in the soil 0.7 m

\*\* The external diameter may differ from the rated up to ± 10 %



## АСБ2лШв 1х400-3 ТУ У 27.3-00214534-091:2017

Power cables with aluminium conductors, with impregnated paper insulation, lead-sheathed, steel-tape armoured, with PVC-compound protection hose

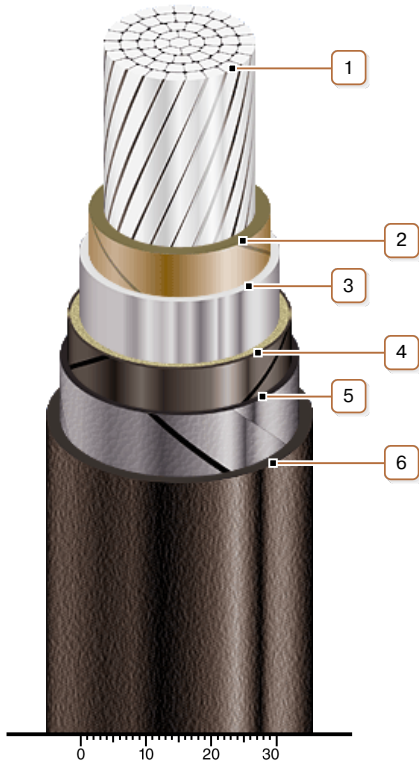

### CONSTRUCTION

1. Aluminium multiwire compacted conductor
2. Impregnated paper insulation
3. Lead sheath
4. Double-layer plastic-tape bedding
5. Double steel-tape armour
6. Pressed PVC compound protection hose