



ЦАСБГ 3x70(ож)-6 ТУ У 27.3-00214534-091:2017

Power cables with aluminium conductors, with non-draining impregnated paper insulation, lead-sheathed, steel-tape armoured

Cables are used for laying:

- without level difference limitation
- in dry premises (tunnels), ducts, cable cellars, mines, collectors, industrial and other premises, including damp, partially flooded premises, environment with medium and high corrosiveness
- in fire-risk premises
- on technological trestles
- on special cable bridges
- with a risk of mechanical damage and no tensile forces in operation

Fire safety code in accordance with ДСТУ 4809:2007: ПБ100000000

Products of this mark meet the requirements:

- single wire cable flame retardance

TECHNICAL SPECIFICATIONS

Rated voltage	kV	6
Number and rated area of conductors	mm ²	3 x 70
Insulation thickness between conductors	mm	4
Insulation thickness of conductor-sheath	mm	2.95
Sheath thickness	mm	1.32
Permissible continuous current rating *		
• by aerial laying	A	178
• by burial	A	180
Operating temperature range	°C	-50 ... +50
Minimum bending radius by laying	mm	540
Metal sheath outer diameter (for reference only)	mm	29
Rated outer diameter of the cable (for reference) **	mm	36
Cable weight (approximate)	kg/km	3190
Rated factory cable length and gross weight of the delivery on the drums ***	m, t	# 16a: 780 • 2.7

Notes:

When ordering it is necessary to agree the factory length of the product with the manufacturer

* Long permissible current loads are calculated for the following conditions: air temperature plus 25 °C, soil temperature plus 15 °C, thermal resistivity of soil 1.2 °K·m/W, laying depth in the soil 0.7 m

** The external diameter may differ from the rated up to ± 10 %

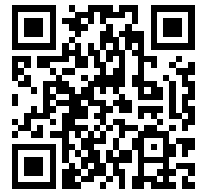

ЦАСБГ 3x70(ож)-6 ТУ У 27.3-00214534-091:2017

Power cables with aluminium conductors, with non-draining impregnated paper insulation, lead-sheathed, steel-tape armoured

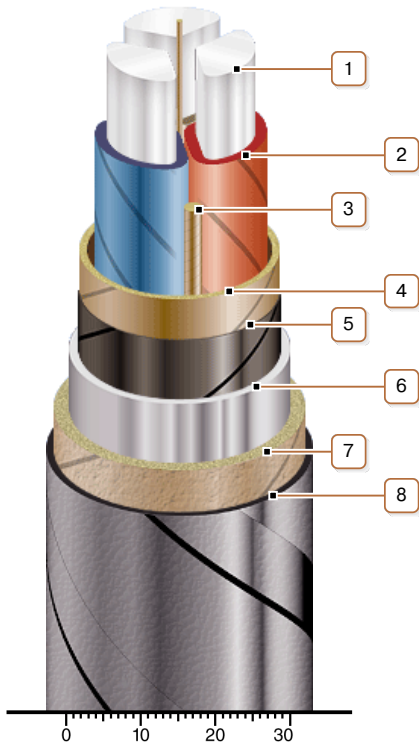

CONSTRUCTION

1. Aluminium conductor
2. Impregnated paper insulation
3. Cable paper bundle
4. Belt insulation
5. Conducting paper screen
6. Lead sheath
7. Bedding
8. Double galvanized steel-tape armour

Note: Conductor twisting is not illustrated