



АСБ2л 3x70-6 ТУ У 27.3-00214534-091:2017

Power cables with aluminium conductors, with impregnated paper insulation, lead-sheathed, steel-tape armoured

Cables are used for laying:

- *in soil (trenches) with high corrosiveness, as well as with vagabond currents*
- *with a risk of mechanical damage and no tensile forces in operation*

TECHNICAL SPECIFICATIONS

Rated voltage	kV	6
Number and rated area of conductors	mm ²	3 x 70
Insulation thickness between conductors	mm	4
Insulation thickness of conductor-sheath	mm	2.95
Sheath thickness	mm	1.36
Permissible continuous current rating *		
• <i>by aerial laying</i>	A	178
• <i>by burial</i>	A	180
Operating temperature range	°C	-50 ... +50
Minimum bending radius by laying	mm	660
Level difference along the laying rout, not more than	m	15
Metal sheath outer diameter (for reference only)	mm	32
Rated outer diameter of the cable (for reference) **	mm	44
Cable weight (approximate)	kg/km	3790
Rated factory cable length and gross weight of the delivery on the drums	m, t	# 16a: 520 • 2.2 # 18: 600 • 2.7

Notes:

When ordering it is necessary to agree the factory length of the product with the manufacturer

** Long permissible current loads are calculated for the following conditions: air temperature plus 25 °C, soil temperature plus 15 °C, thermal resistivity of soil 1.2 °K·m/W, laying depth in the soil 0.7 m*

*** The external diameter may differ from the rated up to ± 10 %*

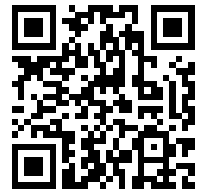

АСБ2л 3x70-6
ТУ У 27.3-00214534-091:2017

Power cables with aluminium conductors, with impregnated paper insulation, lead-sheathed, steel-tape armoured

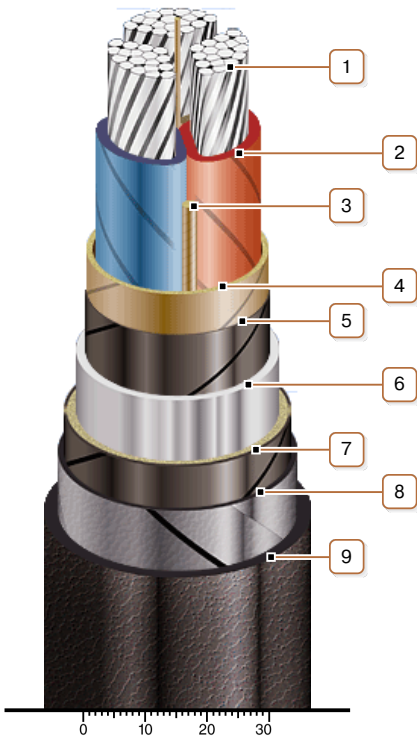

CONSTRUCTION

1. Aluminium multiwire compacted conductor
2. Impregnated paper insulation
3. Cable paper bundle
4. Belt insulation
5. Conducting paper screen
6. Lead sheath
7. Double-layer plastic-tape bedding
8. Double steel-tape armour
9. Outer covering

Note: Conductor twisting is not illustrated