



АСБ2л 4x240(ож)-1 ТУ У 27.3-00214534-091:2017

Power cables with aluminium conductors, with impregnated paper insulation, lead-sheathed, steel-tape armoured

Cables are used for laying:

- in soil (trenches) with high corrosiveness, as well as with vagabond currents
- with a risk of mechanical damage and no tensile forces in operation

TECHNICAL SPECIFICATIONS

Rated voltage	kV	1
Number and rated area of conductors	mm ²	4 x 240
Insulation thickness between conductors	mm	1.9
Insulation thickness of conductor-sheath	mm	1.55
Sheath thickness	mm	1.66
Permissible continuous current rating *		
• by aerial laying	A	374
• by burial	A	334
Operating temperature range	°C	-50 ... +50
Minimum bending radius by laying	mm	870
Level difference along the laying rout, not more than	m	25
Metal sheath outer diameter (for reference only)	mm	47
Rated outer diameter of the cable (for reference) **	mm	58
Cable weight (approximate)	kg/km	7640
Rated factory cable length and gross weight of the delivery on the drums	m, t	# 18: 340 • 3.1 # 20: 550 • 4.8

Notes:

When ordering it is necessary to agree the factory length of the product with the manufacturer

* Long permissible current loads are calculated during operation in four-wire networks with load in all the conductors for the following conditions: air temperature plus 25 °C, soil temperature plus 15 °C, thermal resistivity of soil 1.2 °K·m/W, laying depth in the soil 0.7 m

** The external diameter may differ from the rated up to ± 10 %



АСБ2л 4x240(ож)-1 ТУ У 27.3-00214534-091:2017

Power cables with aluminium conductors, with impregnated paper insulation, lead-sheathed, steel-tape armoured

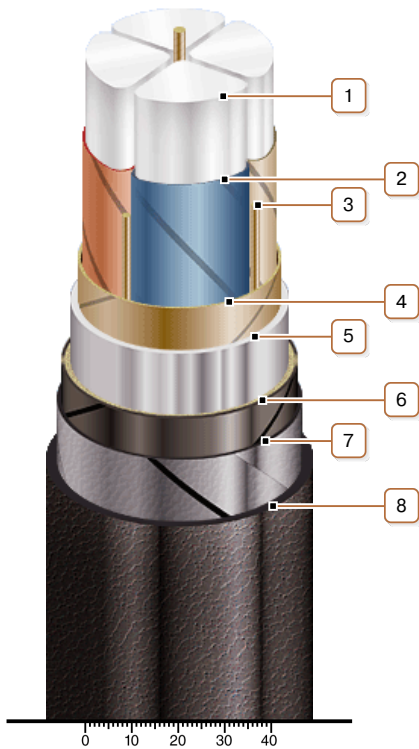

CONSTRUCTION

1. Aluminium conductor
2. Impregnated paper insulation
3. Cable paper bundle
4. Belt insulation
5. Lead sheath
6. Double-layer plastic-tape bedding
7. Double steel-tape armour
8. Outer covering

Note: Conductor twisting is not illustrated