



## АСБл 3x120-1 ТУ У 27.3-00214534-091:2017

Power cables with aluminium conductors, with impregnated paper insulation, lead-sheathed, steel-tape armoured

Cables are used for laying:

- in soil (trenches) with high corrosiveness without vagabond currents
- in soil (trenches) with medium corrosiveness, as well as with vagabond currents
- in mines, non-hazardous as for gas and dust
- with a risk of mechanical damage and no tensile forces in operation

### TECHNICAL SPECIFICATIONS

|  |                 |                                     |
|--|-----------------|-------------------------------------|
| Rated voltage  | kV              | 1                                   |
| Number and rated area of conductors                                      | mm <sup>2</sup> | 3 x 120                             |
| Insulation thickness between conductors                                  | mm              | 1.7                                 |
| Insulation thickness of conductor-sheath                                 | mm              | 1.45                                |
| Sheath thickness   | mm              | 1.42                                |
| Permissible continuous current rating *                                  |                 |                                     |
| • by aerial laying   | A               | 261                                 |
| • by burial  | A               | 248                                 |
| Operating temperature range  | °C              | -50 ... +50                         |
| Minimum bending radius by laying   | mm              | 675                                 |
| Level difference along the laying rout, not more than                    | m               | 25                                  |
| Metal sheath outer diameter (for reference only)                         | mm              | 31                                  |
| Rated outer diameter of the cable (for reference) **                     | mm              | 45                                  |
| Cable weight (approximate)   | kg/km           | 3920                                |
| Rated factory cable length and gross weight of the delivery on the drums | m, t            | # 16a: 480 • 2.1<br># 18: 550 • 2.6 |

Notes:

When ordering it is necessary to agree the factory length of the product with the manufacturer

\* Long permissible current loads are calculated for the following conditions: air temperature plus 25 °C, soil temperature plus 15 °C, thermal resistivity of soil 1.2 °K·m/W, laying depth in the soil 0.7 m

\*\* The external diameter may differ from the rated up to ± 10 %



## АСБл 3x120-1 ТУ У 27.3-00214534-091:2017

Power cables with aluminium conductors, with impregnated paper insulation, lead-sheathed, steel-tape armoured

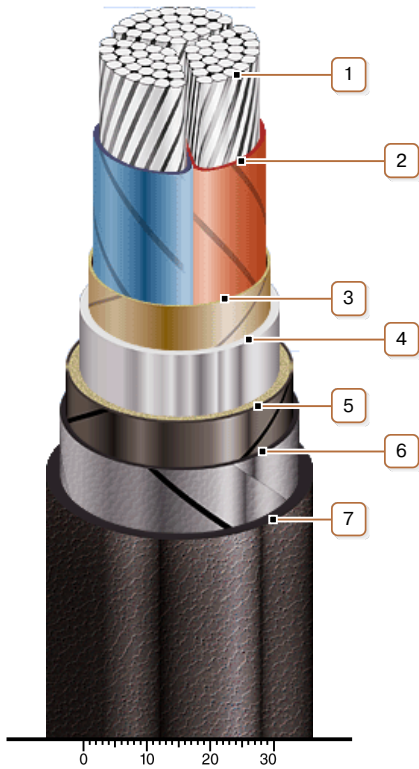

### CONSTRUCTION

1. Aluminium multiwire compacted conductor
2. Impregnated paper insulation
3. Belt insulation
4. Lead sheath
5. Single-layer plastic-tape bedding
6. Double steel-tape armour
7. Outer covering

Note: Conductor twisting is not illustrated