



АСБл 1x500-1 ГОСТ 18410-73, ТУ 16.К71-269-97

Power cables with aluminium conductors, with impregnated paper insulation, lead-sheathed, steel-tape armoured

Cables are used for laying:

- in soil (trenches) with high corrosiveness without vagabond currents
- in soil (trenches) with medium corrosiveness, as well as with vagabond currents
- in mines, non-hazardous as for gas and dust
- with a risk of mechanical damage and no tensile forces in operation

TECHNICAL SPECIFICATIONS

Rated voltage	kV	1
Number and rated area of conductors	mm ²	1 x 500
Insulation thickness of conductor-sheath	mm	2.1
Sheath thickness	mm	1.42
Permissible continuous direct current rating *		
• by aerial laying	A	966
• by burial	A	752
Operating temperature range	°C	-50 ... +50
Minimum bending radius by laying	mm	1125
Level difference along the laying rout, not more than	m	25
Metal sheath outer diameter (for reference only)	mm	34
Rated outer diameter of the cable (for reference) **	mm	45
Cable weight (approximate)	kg/km	4760
Rated factory cable length and gross weight of the delivery on the drums ***	m, t	# 18: 550 • 3.1

Notes:

When ordering it is necessary to agree the factory length of the product with the manufacturer

* Long permissible current loads are calculated for the following conditions: air temperature plus 25 °C, soil temperature plus 15 °C, thermal resistivity of soil 1.2 °K·m/W, laying depth in the soil 0.7 m

** The external diameter may differ from the rated up to ± 10 %



АСБл 1х500-1 ГОСТ 18410-73, ТУ 16.К71-269-97

Power cables with aluminium conductors, with impregnated paper insulation, lead-sheathed, steel-tape armoured

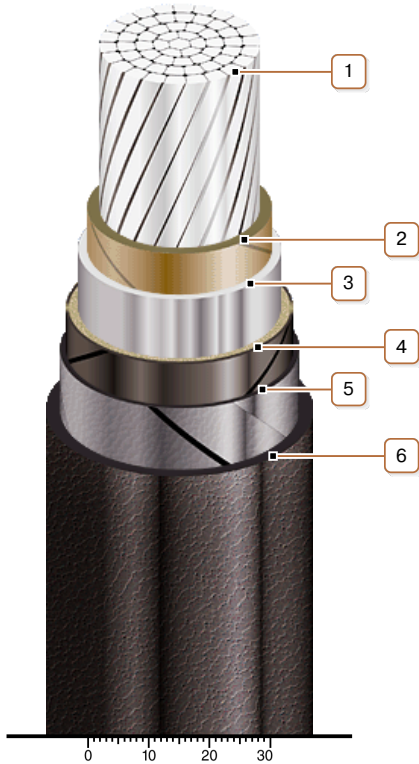

CONSTRUCTION

1. *Aluminium multiwire compacted conductor*
2. *Impregnated paper insulation*
3. *Lead sheath*
4. *Single-layer plastic-tape bedding*
5. *Double steel-tape armour*
6. *Outer covering*