



ACГ 3x150+1x70-1 TY Y 27.3-00214534-091:2017

Power cables with aluminium conductors, with impregnated paper insulation, lead-sheathed

Cables are used for laying:

- *in blocks*
- *with no risk of mechanical damage in operation*

Fire safety code in accordance with ДСТУ 4809:2007: ПБ100000000

Products of this mark meet the requirements:

- *single wire cable flame retardance*

TECHNICAL SPECIFICATIONS

Rated voltage	kV	1
Number and rated area of conductors	mm ²	3 x 150 + 1 x 70
Insulation thickness between conductors	mm	1.7
Insulation thickness of conductor-sheath	mm	1.45
Sheath thickness	mm	2.03
Permissible continuous current rating *		
• <i>by aerial laying</i>	A	300
• <i>by burial</i>	A	281
Operating temperature range	°C	-50 ... +50
Minimum bending radius by laying	mm	645
Level difference along the laying rout, not more than	m	20
Metal sheath outer diameter (for reference only)	mm	40
Rated outer diameter of the cable (for reference) **	mm	43
Cable weight (approximate)	kg/km	4790
Rated factory cable length and gross weight of the delivery on the drums	m, t	# 18: 600 • 3.3

Notes:

When ordering it is necessary to agree the factory length of the product with the manufacturer

* Long permissible current loads are calculated for the following conditions: air temperature plus 25 °C, soil temperature plus 15 °C, thermal resistivity of soil 1.2 °K·m/W, laying depth in the soil 0.7 m

** The external diameter may differ from the rated up to ± 10 %



ACГ 3x150+1x70-1
TY Y 27.3-00214534-091:2017

Power cables with aluminium conductors, with impregnated paper insulation, lead-sheathed

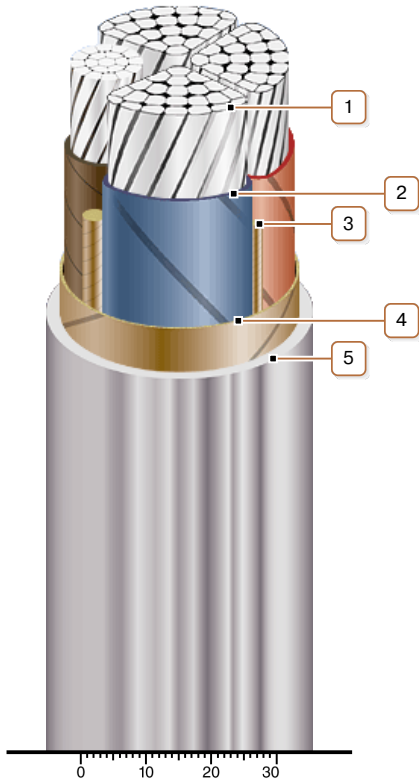

CONSTRUCTION

1. Aluminium multiwire compacted conductor
2. Impregnated paper insulation
3. Cable paper bundle
4. Belt insulation
5. Lead sheath

Note: Conductor twisting is not illustrated