



ААП2лШв 3x185-1 ТУ У 27.3-00214534-091:2017

Power cables with aluminium conductors, with non-draining impregnated paper insulation, aluminium-sheathed, steel-wire armoured, with PVC-compound protection hose

Cables are used for laying:

- in soil (trenches) with high corrosiveness, as well as with vagabond currents
- in dry premises (tunnels), ducts, cable cellars, mines, collectors, industrial and other premises, including damp, partially flooded premises, environment with medium and high corrosiveness
- in fire-risk premises
- on technological trestles
- with a risk of mechanical damage and tensile forces in operation

Fire safety code in accordance with ДСТУ 4809:2007: ПБ100000000

Products of this mark meet the requirements:

- single wire cable flame retardance

TECHNICAL SPECIFICATIONS

Rated voltage	kV	1
Number and rated area of conductors	mm ²	3 x 185
Insulation thickness between conductors	mm	1.9
Insulation thickness of conductor-sheath	mm	1.55
Sheath thickness	mm	1.55
Permissible continuous current rating *		
• by aerial laying	A	342
• by burial	A	314
Operating temperature range	°C	-50 ... +50
Minimum bending radius by laying	mm	1425
Level difference along the laying route, not more than	m	25
Metal sheath outer diameter (for reference only)	mm	40
Rated outer diameter of the cable (for reference) **	mm	57
Cable weight (approximate)	kg/km	5710
Rated factory cable length and gross weight of the delivery on the drums	m, t	# 18: 340 • 2.4 # 20: 550 • 3.8 # 22: 620 • 4.4

Notes:

When ordering it is necessary to agree the factory length of the product with the manufacturer

* Long permissible current loads are calculated for the following conditions: air temperature plus 25 °C, soil temperature plus 15 °C, thermal resistivity of soil 1.2 °K·m/W, laying depth in the soil 0.7 m

** The external diameter may differ from the rated up to ± 10 %



ААП2лШв 3x185-1 ТУ У 27.3-00214534-091:2017

Power cables with aluminium conductors, with non-draining impregnated paper insulation, aluminium-sheathed, steel-wire armoured, with PVC-compound protection hose

CONSTRUCTION

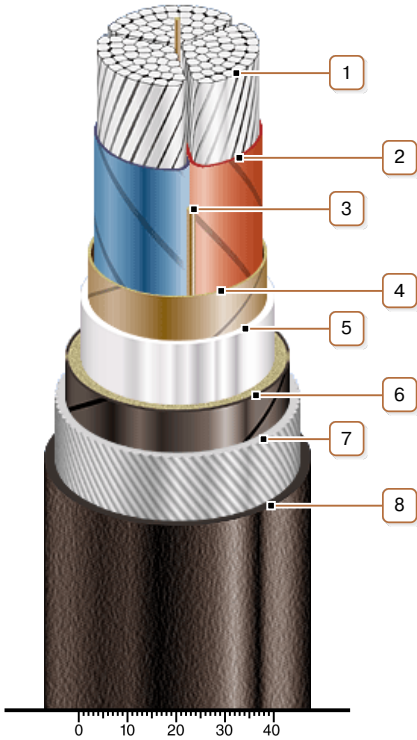

1. Aluminium multiwire compacted conductor
2. Impregnated paper insulation
3. Cable paper bundle
4. Belt insulation
5. Aluminium sheath
6. Double-layer plastic-tape bedding
7. Round galvanized steel-wire armour
8. Pressed PVC compound protection hose

Note: Conductor twisting is not illustrated