

ЦААПлГ 3x35(ож)-10 ТУ У 27.3-00214534-091:2017

Power cables with aluminium conductors, with non-draining impregnated paper insulation, aluminium-sheathed, steel-wire armoured

Cables are used for laying:

- without level difference limitation
- in dry premises (tunnels), ducts, cable cellars, mines, collectors, industrial and other premises, including damp, partially flooded premises, environment with medium and high corrosiveness
- in fire-risk premises
- on technological trestles
- on special cable bridges
- on bridges
- with a risk of mechanical damage and tensile forces in operation

Fire safety code in accordance with ДСТУ 4809:2007: ПБ100000000

Products of this mark meet the requirements:

- single wire cable flame retardance

TECHNICAL SPECIFICATIONS

Rated voltage	kV	10
Number and rated area of conductors	mm ²	3 x 35
Insulation thickness between conductors	mm	5.5
Insulation thickness of conductor-sheath	mm	4
Sheath thickness	mm	1.35
Permissible continuous current rating *		
• by aerial laying	A	106
• by burial	A	110
Operating temperature range	°C	-50 ... +50
Minimum bending radius by laying	mm	1025
Metal sheath outer diameter (for reference only)	mm	28
Rated outer diameter of the cable (for reference) **	mm	41
Cable weight (approximate)	kg/km	3070
Rated factory cable length and gross weight of the delivery on the drums	m, t	# 16a: 570 • 2.0 # 18: 660 • 2.5

Notes:

When ordering it is necessary to agree the factory length of the product with the manufacturer

* Long permissible current loads are calculated for the following conditions: air temperature plus 25 °C, soil temperature plus 15 °C, thermal resistivity of soil 1.2 °K·m/W, laying depth in the soil 0.7 m

** The external diameter may differ from the rated up to ± 10 %

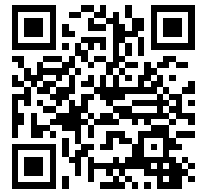

ЦААПЛГ 3x35(ож)-10 ТУ У 27.3-00214534-091:2017

Power cables with aluminium conductors, with non-draining impregnated paper insulation, aluminium-sheathed, steel-wire armoured

CONSTRUCTION

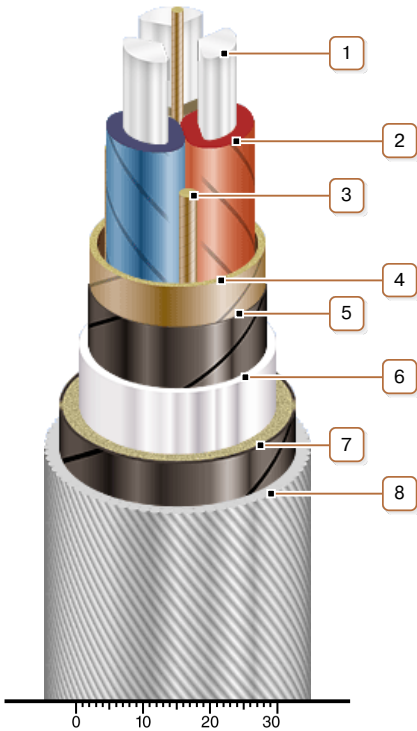

1. Aluminium conductor
2. Impregnated paper insulation
3. Cable paper bundle
4. Belt insulation
5. Conducting paper screen
6. Aluminium sheath
7. Single-layer plastic-tape bedding
8. Round galvanized steel-wire armour

Note: Conductor twisting is not illustrated