



## ААБнлГ 3х35(ож)-6 ТУ У 27.3-00214534-091:2017

Power cables with aluminium conductors, with impregnated paper insulation, aluminium-sheathed, steel-tape armoured

Cables are used for laying:

- in dry premises (tunnels), ducts, cable cellars, mines, collectors, industrial and other premises, including damp, partially flooded premises, environment with medium and high corrosiveness
- in fire-risk premises
- on technological trestles
- on special cable bridges
- on bridges
- with a risk of mechanical damage and no tensile forces in operation
- in bunches

Fire safety code in accordance with ДСТУ 4809:2007: ПБ120000000

Products of this mark meet the requirements:

- single wire cable flame retardance
- bunched cable flame retardance category A

### TECHNICAL SPECIFICATIONS

Rated voltage	kV	6
Number and rated area of conductors	mm <sup>2</sup>	3 x 35
Insulation thickness between conductors	mm	4
Insulation thickness of conductor-sheath	mm	2.95
Sheath thickness	mm	1.3
Permissible continuous current rating *		
• by aerial laying	A	117
• by burial	A	121
Operating temperature range	°C	-50 ... +50
Minimum bending radius by laying	mm	800
Level difference along the laying rout, not more than	m	20
Metal sheath outer diameter (for reference only)	mm	24
Rated outer diameter of the cable (for reference) **	mm	32
Cable weight (approximate)	kg/km	1670
Rated factory cable length and gross weight of the delivery on the drums	m, t	# 16: 370 • 0.9

Notes:

When ordering it is necessary to agree the factory length of the product with the manufacturer

\* Long permissible current loads are calculated for the following conditions: air temperature plus 25 °C, soil temperature plus 15 °C, thermal resistivity of soil 1.2 °K·m/W, laying depth in the soil 0.7 m

\*\* The external diameter may differ from the rated up to ± 10 %



## ААБнлГ 3х35(ож)-6 ТУ У 27.3-00214534-091:2017

Power cables with aluminium conductors, with impregnated paper insulation, aluminium-sheathed, steel-tape armoured

### CONSTRUCTION

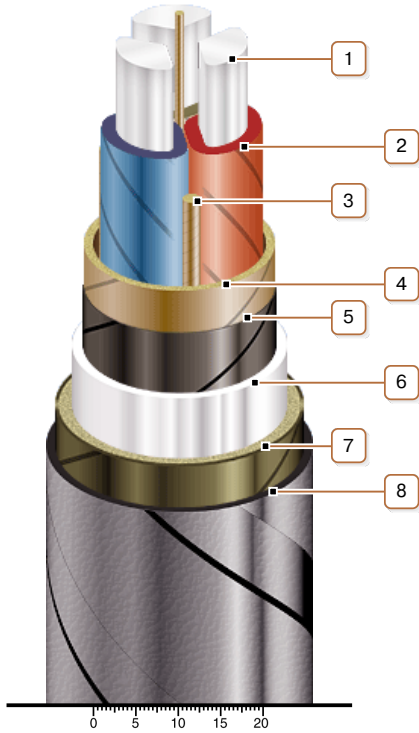

1. Aluminium conductor
2. Impregnated paper insulation
3. Cable paper bundle
4. Belt insulation
5. Conducting paper screen
6. Aluminium sheath
7. Plastic-tape and glass-tape bedding
8. Double galvanized steel-tape armour

Note: Conductor twisting is not illustrated