



ЦААБлГ 3x95-6 ТУ У 27.3-00214534-091:2017

Power cables with aluminium conductors, with non-draining impregnated paper insulation, aluminium-sheathed, steel-tape armoured

Cables are used for laying:

- *without level difference limitation*
- *in dry premises (tunnels), ducts, cable cellars, mines, collectors, industrial and other premises, including damp, partially flooded premises, environment with medium and high corrosiveness*
- *in fire-risk premises*
- *on technological trestles*
- *on special cable bridges*
- *on bridges*
- *with a risk of mechanical damage and no tensile forces in operation*

Fire safety code in accordance with ДСТУ 4809:2007: ПБ100000000

Products of this mark meet the requirements:

- *single wire cable flame retardance*

TECHNICAL SPECIFICATIONS

Rated voltage	kV	6
Number and rated area of conductors	mm ²	3 x 95
Insulation thickness between conductors	mm	4
Insulation thickness of conductor-sheath	mm	2.95
Sheath thickness	mm	1.45
Permissible continuous current rating *		
• <i>by aerial laying</i>	A	214
• <i>by burial</i>	A	213
Operating temperature range	°C	-50 ... +50
Minimum bending radius by laying	mm	1000
Metal sheath outer diameter (for reference only)	mm	34
Rated outer diameter of the cable (for reference) **	mm	40
Cable weight (approximate)	kg/km	2740
Rated factory cable length and gross weight of the delivery on the drums	m, t	# 18: 720 • 2.4

Notes:

When ordering it is necessary to agree the factory length of the product with the manufacturer

** Long permissible current loads are calculated for the following conditions: air temperature plus 25 °C, soil temperature plus 15 °C, thermal resistivity of soil 1.2 °K·m/W, laying depth in the soil 0.7 m*

*** The external diameter may differ from the rated up to ± 10 %*



ЦААБЛГ 3x95-6
ТУ У 27.3-00214534-091:2017

Power cables with aluminium conductors, with non-draining impregnated paper insulation, aluminium-sheathed, steel-tape armoured

CONSTRUCTION

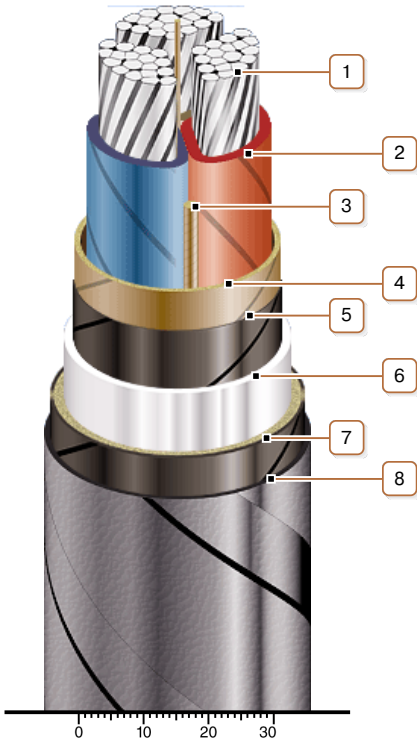

1. Aluminium multiwire compacted conductor
2. Impregnated paper insulation
3. Cable paper bundle
4. Belt insulation
5. Conducting paper screen
6. Aluminium sheath
7. Single-layer plastic-tape bedding
8. Double galvanized steel-tape armour

Note: Conductor twisting is not illustrated