



ЦААШВ 3x95-10 TY Y 27.3-00214534-091:2017

Power cables with aluminium conductors, with non-draining impregnated paper insulation, aluminium-sheathed, with PVC-compound protection hose

Cables are used for laying:

- without level difference limitation
- in soil (trenches) with high corrosiveness without vagabond currents
- in soil (trenches) with medium corrosiveness, as well as with vagabond currents
- in dry premises (tunnels), ducts, cable cellars, mines, collectors, industrial and other premises, including damp, partially flooded premises, environment with medium and high corrosiveness
- in fire-risk premises
- on special cable bridges
- on bridges
- in mines, non-hazardous as for gas and dust
- with no risk of mechanical damage in operation

Fire safety code in accordance with ДСТУ 4809:2007: ПБ100000000

Products of this mark meet the requirements:

- single wire cable flame retardance

TECHNICAL SPECIFICATIONS

| | | |
|--|-----------------|-----------------|
| Rated voltage | kV | 10 |
| Number and rated area of conductors | mm ² | 3 x 95 |
| Insulation thickness between conductors | mm | 5.5 |
| Insulation thickness of conductor-sheath | mm | 4 |
| Sheath thickness | mm | 1.55 |
| Permissible continuous current rating * | | |
| • by aerial laying | A | 194 |
| • by burial | A | 192 |
| Operating temperature range | °C | -50 ... +50 |
| Minimum bending radius by laying | mm | 1100 |
| Metal sheath outer diameter (for reference only) | mm | 38 |
| Rated outer diameter of the cable (for reference) ** | mm | 44 |
| Cable weight (approximate) | kg/km | 2540 |
| Rated factory cable length and gross weight of the delivery on the drums *** | m, t | # 18: 600 • 2.0 |

Notes:

When ordering it is necessary to agree the factory length of the product with the manufacturer

* Long permissible current loads are calculated for the following conditions: air temperature plus 25 °C, soil temperature plus 15 °C, thermal resistivity of soil 1.2 °K·m/W, laying depth in the soil 0.7 m

** The external diameter may differ from the rated up to ± 10 %

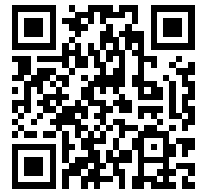

ЦААШВ 3x95-10
ТУ У 27.3-00214534-091:2017

Power cables with aluminium conductors, with non-draining impregnated paper insulation, aluminium-sheathed, with PVC-compound protection hose

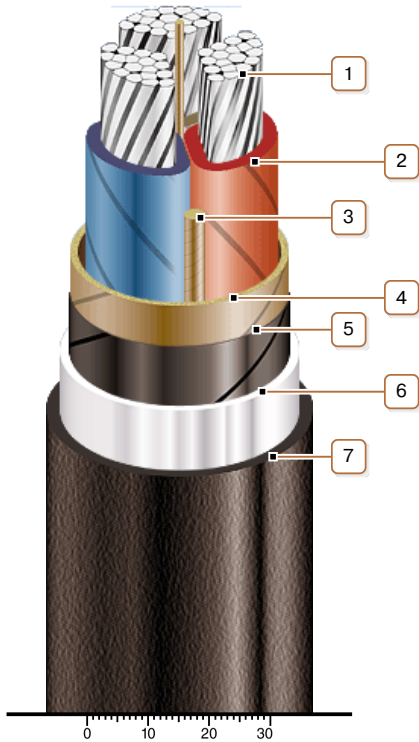

CONSTRUCTION

1. Aluminium multiwire compacted conductor
2. Impregnated paper insulation
3. Cable paper bundle
4. Belt insulation
5. Conducting paper screen
6. Aluminium sheath
7. Pressed PVC compound protection hose

Note: Conductor twisting is not illustrated