

ААШВ 3x150(ож)-10 ТУ У 27.3-00214534-091:2017

Power cables with aluminium conductors, with impregnated paper insulation, aluminium-sheathed, with PVC-compound protection hose

Cables are used for laying:

- in soil (trenches) with high corrosiveness without vagabond currents
- in soil (trenches) with medium corrosiveness, as well as with vagabond currents
- in dry premises (tunnels), ducts, cable cellars, mines, collectors, industrial and other premises, including damp, partially flooded premises, environment with medium and high corrosiveness
- in fire-risk premises
- on special cable bridges
- on bridges
- in mines, non-hazardous as for gas and dust
- with no risk of mechanical damage in operation

Fire safety code in accordance with ДСТУ 4809:2007: ПБ100000000

Products of this mark meet the requirements:

- single wire cable flame retardance

TECHNICAL SPECIFICATIONS

Rated voltage	kV	10
Number and rated area of conductors	mm ²	3 x 150
Insulation thickness between conductors	mm	5.5
Insulation thickness of conductor-sheath	mm	4
Sheath thickness	mm	1.65
Permissible continuous current rating *		
• by aerial laying	A	264
• by burial	A	246
Operating temperature range	°C	-50 ... +50
Minimum bending radius by laying	mm	1175
Level difference along the laying rout, not more than	m	15
Metal sheath outer diameter (for reference only)	mm	41
Rated outer diameter of the cable (for reference) **	mm	47
Cable weight (approximate)	kg/km	3320
Rated factory cable length and gross weight of the delivery on the drums ***	m, t	# 18: 500 • 2.1

Notes:

When ordering it is necessary to agree the factory length of the product with the manufacturer

* Long permissible current loads are calculated for the following conditions: air temperature plus 25 °C, soil temperature plus 15 °C, thermal resistivity of soil 1.2 °K·m/W, laying depth in the soil 0.7 m

** The external diameter may differ from the rated up to ± 10 %

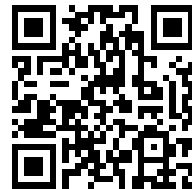

ААШВ 3x150(ож)-10 ТУ У 27.3-00214534-091:2017

Power cables with aluminium conductors, with impregnated paper insulation, aluminium-sheathed, with PVC-compound protection hose

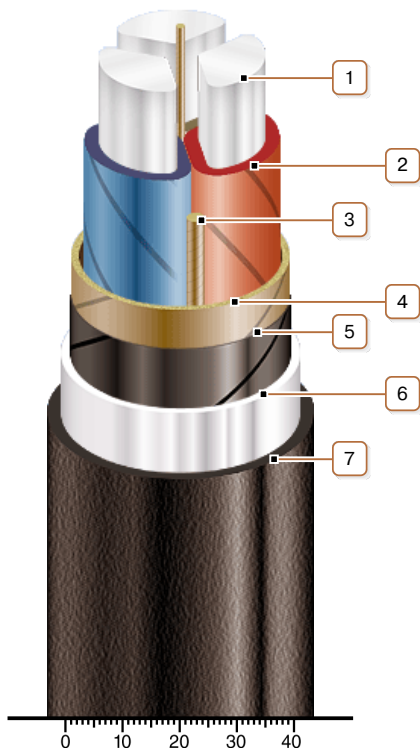

CONSTRUCTION

1. Aluminium conductor
2. Impregnated paper insulation
3. Cable paper bundle
4. Belt insulation
5. Conducting paper screen
6. Aluminium sheath
7. Pressed PVC compound protection hose

Note: Conductor twisting is not illustrated