



ААГ 3x185+1x95(ож)-1 TY Y 27.3-00214534-091:2017

Power cables with aluminium conductors, with impregnated paper insulation, aluminium-sheathed

Cables are used for laying:

- in dry premises (tunnels), ducts, cable cellars, mines, collectors, industrial and other premises
- in fire-risk premises
- with no risk of mechanical damage in operation

Fire safety code in accordance with ДСТУ 4809:2007: ПБ100000000

Products of this mark meet the requirements:

- single wire cable flame retardance

TECHNICAL SPECIFICATIONS

Rated voltage	kV	1
Number and rated area of conductors	mm ²	3 x 185 + 1 x 95
Insulation thickness between conductors	mm	1.9
Insulation thickness of conductor-sheath	mm	1.55
Sheath thickness	mm	1.55
Permissible continuous current rating *		
• by aerial laying	A	342
• by burial	A	314
Operating temperature range	°C	-50 ... +50
Minimum bending radius by laying	mm	1025
Level difference along the laying rout, not more than	m	25
Metal sheath outer diameter (for reference only)	mm	40
Rated outer diameter of the cable (for reference) **	mm	41
Cable weight (approximate)	kg/km	2700
Rated factory cable length and gross weight of the delivery on the drums	m, t	# 18: 660 • 2.2

Notes:

When ordering it is necessary to agree the factory length of the product with the manufacturer

* Long permissible current loads are calculated for the following conditions: air temperature plus 25 °C, soil temperature plus 15 °C, thermal resistivity of soil 1.2 °K·m/W, laying depth in the soil 0.7 m

** The external diameter may differ from the rated up to ± 10 %



ААГ 3x185+1x95(ож)-1
ТУ У 27.3-00214534-091:2017

Power cables with aluminium conductors, with impregnated paper insulation, aluminium-sheathed

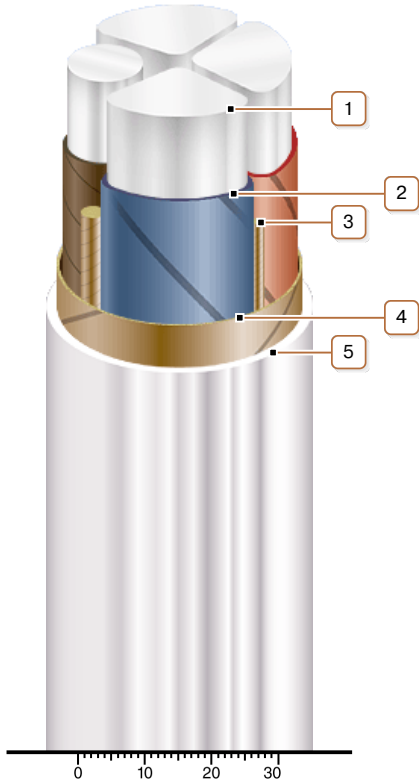

CONSTRUCTION

1. Aluminium conductor
2. Impregnated paper insulation
3. Cable paper bundle
4. Belt insulation
5. Aluminium sheath

Note: Conductor twisting is not illustrated