

АПвЭгаПнг-330 1x1000 ТУ У 31.3-00214534-061:2008

Power cables with aluminium conductor, flame-retardant, with XLPE, longitudinal and transverse screen sealing and polymer compound outer sheath

For the cable of this mark correspond the foreign-made analogues:

АНХСНВМК (FI)

Technical cable requirements correspond to IEC 62067

Cables are used for laying:

- *in premises, tunnels, ducts, mines, dry soil and outdoor under shelter*
- *single laying*

It is possible to manufacture cable with a segmented conductor

It is possible to manufacture cables with extruded semiconductor layer along outer sheath.

Order entry example:

АПвЭгаПнг-П-330 1x1000/95 ТУ У 31.3-00214534-061:2008

An extruded semiconductor layer along outer sheath ensures the correct testing of cable line with sections of underground laying in polymer pipes.

It is possible to manufacture cables with an integrated fiber-optic module.

Order entry example:

АПвЭгаПнг-330 1x1000/95 (ОМ) ТУ У 31.3-00214534-061:2008

In conjunction with the DTS system, the integrated fiber-optic module can act as a distributed cable line temperature sensor.

It is possible to manufacture cable with sealed conductor.

Order entry example:

АПвЭгаПнг-330 1x1000/95 (Г) ТУ У 31.3-00214534-061:2008

Fire safety code in accordance with ДСТУ 4809:2007: ПБ101222000

Products of this mark meet the requirements:

- *single wire cable flame retardance*
- *toxicity class Tk1 of the combustion products of nonmetallic elements (toxicity index from 13 up to 40 g/m³)*
- *class ДТк2 on smoke-forming ability by smouldering of non-metallic elements (coefficient of smoke formation less than 50 m²/kg)*
- *class ДПк2 on smoke-forming ability by combustion (minimum luminous flux more than 60 %)*
- *corrosive class Кк2 of combustion products of non-metallic elements (the number of halogen hydrides less than 150 mg/g, pH more than 4.3, specific conductivity less than 10 μS/mm)*



АПвЭгаПнг-330 1x1000 ТУ У 31.3-00214534-061:2008

Power cables with aluminium conductor, flame-retardant, with XLPE, longitudinal and transverse screen sealing and polymer compound outer sheath

TECHNICAL SPECIFICATIONS

Rated voltage	kV	330
Maximum voltage	kV	363
Conductor rated area	mm ²	1000
Minimum screen cross-section	mm ²	95
Partial discharge factor for rated voltage, not more than	pC	6
Permissible short circuit current across the screen of minimum cross-section	kA	19.3
Maximum permissible short-circuit current in core	kA	94
Permissible continuous current rating by aerial laying *		
• in trefoil formation with double-side screen earthing	A	995
• in trefoil formation with single-side screen earthing or cross screen earthing	A	1045
• plane with double-side screen earthing	A	999
• plane with single-side screen earthing or cross screen earthing	A	1189
Permissible continuous current rating by burial *		
• in trefoil formation with double-side screen earthing	A	731
• in trefoil formation with single-side screen earthing or cross screen earthing	A	788
• plane with double-side screen earthing	A	662
• plane with single-side screen earthing or cross screen earthing	A	833
Maximum permissible conductor temperature		
• Continuous	°C	+90
• in emergency operation	°C	+130
• at short circuit	°C	+250
Operating temperature range	°C	-60 ... +50
Minimum bending radius by laying	mm	1856
Rated outer diameter of the cable (for reference) **	mm	116
Cable weight (approximate)	kg/km	14180

Notes:

When ordering it is necessary to agree the factory length of the product with the manufacturer

* Long permissible current loads are calculated for the following conditions: conductor temperature 90 °C, air temperature 30 °C, soil temperature 20 °C, load factor 1.0, thermal resistivity of soil 1.0 °K·m/W, laying depth in the ground 1.5 m, while laying in flat formation the distance between cables in clear is equal to the cable diameter, while laying in trefoil formation cables are laid side by side

** The external diameter may differ from the rated up to ± 10 %

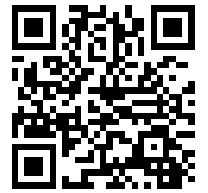

АПвЭгаПнг-330 1x1000 ТУ У 31.3-00214534-061:2008

Power cables with aluminium conductor, flame-retardant, with XLPE, longitudinal and transverse screen sealing and polymer compound outer sheath

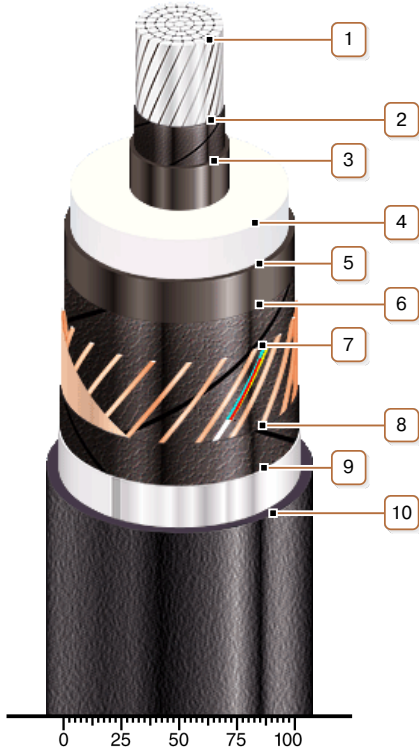

CONSTRUCTION

1. Aluminium multiwire compacted conductor

Notes:

- It is possible to manufacture cable with a segmented conductor
- It is possible to manufacture cable with sealed conductor.

2. Lapping layer of semiconductive swellable tape

3. Inner extruded semiconducting layer

4. XLPE insulation

5. Outer extruded semiconducting layer

6. Lapping layer of semiconductive swellable tape

7. Copper screen with an integrated fiber-optic module (optional)

8. Lapping layer of semiconductive swellable tape

9. Alumopolymer tape

10. Flame-retardant polymer compound outer sheath

Note: It is possible to manufacture cable with extruded semiconductor layer along outer sheath