



АПвЭгаП-220 1x1400 **ТУ У 31.3-00214534-061:2008**

Power cables with aluminium conductor, with XLPE, longitudinal and transverse screen sealing and polyethylene outer sheath

For the cable of this mark correspond the foreign-made analogues:

NA2XS(FL)2Y (DE) • A2XS(FL)2Y (DE) • AHXCHBMK (FI) • AI/XLPE/CWS/LW/MDPE (GB) • XRUHAKXS (PL) • АПвП2г (RU)

Technical cable requirements correspond to IEC 62067

Cables are used for laying:

- *in soil (trenches)*
- *in damp, partially flooded premises*
- *in ground with high humidity*
- *in non-navigable waters*
- *in the air, including cable structures, if provided the additional fire protection*

It is possible to manufacture cables with extruded semiconductor layer along outer sheath.

Order entry example:

АПвЭгаП-П-220 1x1400/95 ТУ У 31.3-00214534-061:2008

An extruded semiconductor layer along outer sheath ensures the correct testing of cable line with sections of underground laying in polymer pipes.

It is possible to manufacture cables with an integrated fiber-optic module.

Order entry example:

АПвЭгаП-220 1x1400/95 (OM) ТУ У 31.3-00214534-061:2008

In conjunction with the DTS system, the integrated fiber-optic module can act as a distributed cable line temperature sensor.

It is possible to manufacture cable with sealed conductor.

Order entry example:

АПвЭгаП-220 1x1400/95 (r) ТУ У 31.3-00214534-061:2008



АПвЭгаП-220 1x1400 ТУ У 31.3-00214534-061:2008

Power cables with aluminium conductor, with XLPE, longitudinal and transverse screen sealing and polyethylene outer sheath

TECHNICAL SPECIFICATIONS

Rated voltage	kV	220
Maximum voltage	kV	252
Conductor rated area	mm ²	1400
Minimum screen cross-section	mm ²	95
Partial discharge factor for rated voltage, not more than	pC	6
Permissible short circuit current across the screen of minimum cross-section	kA	19.3
Maximum permissible short-circuit current in core	kA	132
Permissible continuous current rating by aerial laying *		
• in trefoil formation with double-side screen earthing	A	1329
• in trefoil formation with single-side screen earthing or cross screen earthing	A	1483
• plane with double-side screen earthing	A	1261
• plane with single-side screen earthing or cross screen earthing	A	1700
Permissible continuous current rating by burial *		
• in trefoil formation with double-side screen earthing	A	925
• in trefoil formation with single-side screen earthing or cross screen earthing	A	1082
• plane with double-side screen earthing	A	791
• plane with single-side screen earthing or cross screen earthing	A	1145
Maximum permissible conductor temperature		
• Continuous	°C	+90
• in emergency operation	°C	+130
• at short circuit	°C	+250
Operating temperature range	°C	-60 ... +50
Minimum bending radius by laying	mm	1840
Rated outer diameter of the cable (for reference) **	mm	115
Cable weight (approximate)	kg/km	15060

Notes:

When ordering it is necessary to agree the factory length of the product with the manufacturer

* Long permissible current loads are calculated for the following conditions: conductor temperature 90 °C, air temperature 30 °C, soil temperature 20 °C, load factor 1.0, thermal resistivity of soil 1.0 °K·m/W, laying depth in the ground 1.5 m, while laying in flat formation the distance between cables in clear is equal to the cable diameter, while laying in trefoil formation cables are laid side by side

** The external diameter may differ from the rated up to ± 10 %



АПвЭгаП-220 1x1400 ТУ У 31.3-00214534-061:2008

Power cables with aluminium conductor, with XLPE, longitudinal and transverse screen sealing and polyethylene outer sheath

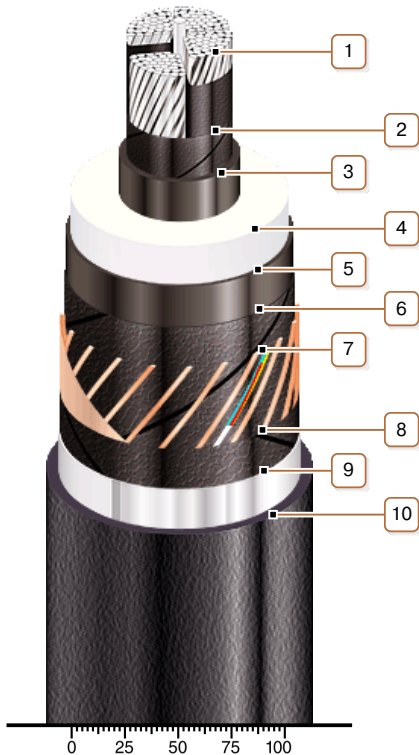

CONSTRUCTION

1. Aluminium multiwire compacted conductor

Notes:

- It is possible to manufacture cable with sealed conductor.
- Conductor segment twisting is not illustrated

2. Lapping layer of semiconductive swellable tape

3. Inner extruded semiconducting layer

4. XLPE insulation

5. Outer extruded semiconducting layer

6. Lapping layer of semiconductive swellable tape

7. Copper screen with an integrated fiber-optic module (optional)

8. Lapping layer of semiconductive swellable tape

9. Alumopolymer tape

10. Outer sheath of polyethylene or polyethylene copolymer

Note: It is possible to manufacture cable with extruded semiconductor layer along outer sheath