



## **ПвЭВнгд(к)-15 3x35 ТУ У 31.3-00214534-017-2003**

Three core power cables with copper conductors, XLPE-insulated, core-filled with bundles, with outer sheath of PVC compound, flame retardant, with low smoke and gas emission

Technical cable requirements correspond to IEC 60502-2

Cables are used for laying:

- *in premises, tunnels, ducts, mines, dry soil and outdoor under shelter*
- *in bunches*
- *at sites, where low smoke and gas emission are required (NPP, subway, large industrial facilities, high-rise buildings, etc.)*

It is possible to manufacture cables with an integrated fiber-optic module.

Order entry example:

ПвЭВнгд(к)-15 3x35/16 (ОМ) ТУ У 31.3-00214534-017-2003

In conjunction with the DTS system, the integrated fiber-optic module can act as a distributed cable line temperature sensor.

It is possible to manufacture cable with sealed conductors.

Order entry example:

ПвЭВнгд(к)-15 3x35/16 (r) ТУ У 31.3-00214534-017-2003

Fire safety code in accordance with ДСТУ 4809:2007: ПБ132121000

Products of this mark meet the requirements:

- *single wire cable flame retardance*
- *bunched cable flame retardance category B*
- *toxicity class Tk2 of the combustion products of nonmetallic elements (toxicity index from 40 up to 120 g/m<sup>3</sup>)*
- *class ДТк1 on smoke-forming ability by smouldering of non-metallic elements (coefficient of smoke formation from 50 to 500 m<sup>2</sup>/kg)*
- *class ДПк2 on smoke-forming ability by combustion (minimum luminous flux more than 60 %)*
- *corrosive class Кк1 of combustion products of non-metallic elements (the number of halogen hydrides less than 150 mg/g, pH less than 4.3, specific conductivity more than 10 μS/mm)*



## ПвЭВнгд(к)-15 3x35 ТУ У 31.3-00214534-017-2003

Three core power cables with copper conductors, XLPE-insulated, core-filled with bundles, with outer sheath of PVC compound, flame retardant, with low smoke and gas emission

### TECHNICAL SPECIFICATIONS

Rated voltage	kV	15
Maximum voltage	kV	17.5
Number and rated area of conductors	mm <sup>2</sup>	3 x 35
Insulation thickness	mm	4.5
Minimum screen cross-section	mm <sup>2</sup>	16
Permissible short circuit current across the screen of minimum cross-section	kA	3.3
Maximum permissible short-circuit current in core	kA	5
Permissible continuous current rating *		
• by aerial laying	A	132
• by burial	A	119
Partial discharge factor for rated voltage, not more than	pC	6
Maximum permissible conductor temperature		
• Continuous	°C	+90
• in emergency operation	°C	+130
• at short circuit	°C	+250
Operating temperature range (in climate version NF)	°C	-50 ... +50
Operating temperature range (in climate version T)	°C	-25 ... +65
Minimum bending radius by laying	mm	784
Rated outer diameter of the cable (for reference) **	mm	49
Cable weight (approximate)	kg/km	2600
Rated factory cable length and gross weight of the delivery on the drums ***	m, t	# 22УД-60: 661 • 2.6 # 20аУД-60: 810 • 2.8 # 25УД-90: 1323 • 5.0

#### Notes:

When ordering it is necessary to agree the factory length of the product with the manufacturer

\* Long permissible current loads are calculated for the following conditions: conductor temperature 90 °C, air temperature 30 °C, soil temperature 20 °C, load factor 1.0, thermal resistivity of soil 1.5 °K·m/W, laying depth in the ground 0.8 m, shields are grounded at both ends of the line

\*\* The external diameter may differ from the rated up to ± 10 %

\*\*\* Отклонение фактической массы брутто от указанного значения может составлять ± 7 %



## ПвЭВнгд(к)-15 3x35 ТУ У 31.3-00214534-017-2003

Three core power cables with copper conductors, XLPE-insulated, core-filled with bundles, with outer sheath of PVC compound, flame retardant, with low smoke and gas emission

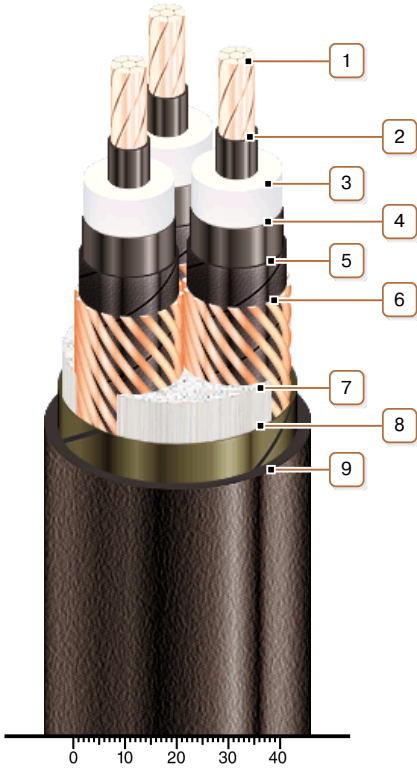

### CONSTRUCTION

**1. Copper multiwire compact conductor**

*Note: It is possible to manufacture cable with sealed conductors.*

**2. Inner extruded semiconducting layer**

**3. XLPE insulation**

**4. Outer extruded semiconducting layer**

**5. Lapping layer of semiconductive swellable tape**

**6. Copper screen**

**7. Interstitial filler with polypropylene bundles**

**8. Lapping layer of glass tape**

**9. Low fire-risk PVC compound outer sheath**

*Note: Conductor twisting is not illustrated*