



## **ПвАПу-10 1x185** **ТУ У 27.3-00214534-092:2016**

Single-core power cables with copper conductors, XLPE-insulated, aluminium sheathed, with reinforced outer sheath of polyethylene

---

Technical cable requirements correspond to IEC 60502-2

Cables are used for laying:

- *in places, where small mechanical impacts on cable are possible, including tensile forces*
- *in soil (trenches)*
- *in damp, partially flooded premises*
- *on difficult route sections, according to the unique specification*
- *in the air, including cable structures, if provided the additional fire protection*

---

It is possible to manufacture cables with extruded semiconductor layer along outer sheath.

Order entry example:

ПвАПу-П-10 1x185/25 ТУ У 27.3-00214534-092:2016

An extruded semiconductor layer along outer sheath ensures the correct testing of cable line with sections of underground laying in polymer pipes.

---

It is possible to manufacture cables with an integrated fiber-optic module.

Order entry example:

ПвАПу-10 1x185/25 (OM) ТУ У 27.3-00214534-092:2016

In conjunction with the DTS system, the integrated fiber-optic module can act as a distributed cable line temperature sensor.

---

Cables with copper screen can also be manufactured

---

It is possible to manufacture cable with sealed conductor.

Order entry example:

ПвАПу-10 1x185/25 (r) ТУ У 27.3-00214534-092:2016

---

It is possible to supply of three stranded single-core cables.

Order entry example:

3xПвАПу-10 1x185/25 ТУ У 27.3-00214534-092:2016

---



## ПвАПу-10 1x185 ТУ У 27.3-00214534-092:2016

Single-core power cables with copper conductors, XLPE-insulated, aluminium sheathed, with reinforced outer sheath of polyethylene

### TECHNICAL SPECIFICATIONS

Rated voltage	kV	10
Maximum voltage	kV	12
Number and rated area of conductors	mm <sup>2</sup>	1 x 185
Insulation thickness	mm	3.4
Sheath thickness	mm	1.4
Maximum permissible short-circuit current in core	kA	26.5
Permissible continuous current rating *		
• by aerial laying in trefoil formation	A	543
• by aerial flat laying	A	637
• by burial in trefoil formation	A	406
• by burial flat	A	410
Partial discharge factor for rated voltage, not more than	pC	6
Maximum permissible conductor temperature		
• Continuous	°C	+90
• in emergency operation	°C	+130
• at short circuit	°C	+250
Operating temperature range	°C	-60 ... +50
Minimum bending radius by laying	mm	875
Rated outer diameter of the cable (for reference) **	mm	35
Cable weight (approximate)	kg/km	2700
Rated factory cable length and gross weight of the delivery on the drums	m, t	# 18аУД-40: 1299 • 4.0

#### Notes:

When ordering it is necessary to agree the factory length of the product with the manufacturer

\* Long permissible current loads are calculated for the following conditions: conductor temperature 90 °C, air temperature 30 °C, soil temperature 20 °C, thermal resistivity of soil 1.5 °K·m/W, laying depth in the soil 0.8 m, while laying in flat formation the distance between cables in clear is equal to the cable diameter, while laying in trefoil formation cables are laid side by side, shields are earthed on both ends of the line

\*\* The external diameter may differ from the rated up to ± 10 %



## ПвАПу-10 1x185 ТУ У 27.3-00214534-092:2016

Single-core power cables with copper conductors, XLPE-insulated, aluminium sheathed, with reinforced outer sheath of polyethylene

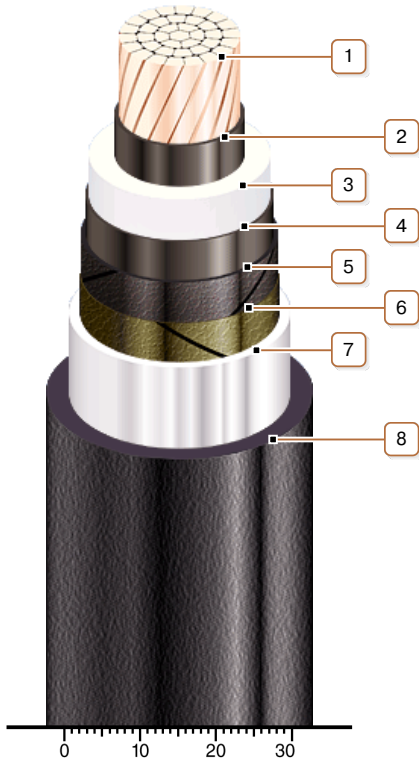

### CONSTRUCTION

**1. Copper multiwire compact conductor**

*Note: It is possible to manufacture cable with sealed conductor.*

**2. Inner extruded semiconducting layer**

**3. XLPE insulation**

**4. Outer extruded semiconducting layer**

**5. Lapping layer of semiconductive swellable tape**

**6. Lapping layer of semiconductive tape**

**7. Aluminium sheath**

**8. Strengthened polyethylene outer sheath**

*Note: It is possible to manufacture cable with extruded semiconductor layer along outer sheath*

*Note: Cables with copper screen can also be manufactured*